

# FLEX-AUGER® Reference Manual

MODEL 55, 75, HMC, 90, & 108  
MULTIFLO®  
Drop Feeding  
FLAG™

## Chore-Time Warranty

**Chore-Time Poultry Production Systems**, a division of CTB, Inc., (“Chore-Time”), warrants each new CHORE-TIME® product manufactured by it to be free from defects in material or workmanship for one-year from and after the date of initial installation by or for the original purchaser. If such a defect is found by Chore-Time to exist within the one-year period, Chore-Time will, at its option, (a) repair or replace such product free of charge, F.O.B. the factory of manufacture, or (b) refund to the original purchaser the original purchase price, in lieu of such repair or replacement. Labor costs associated with the replacement or repair of the product are not covered by the Manufacturer.

Additional extended warranties for the equipment and/or systems listed below are provided to the original purchaser as follows (for all other CHORE-TIME® products purchased, the one-year warranty period shall apply):

1. TURBO® and RLX™ fans, less motors - 3 years
2. TURBO® fan fiberglass housings, polyethylene cones, and cast aluminum blades - for the life of the product
3. TURBO® fan motors and bearings - 2 years
4. TURBO® fan components (including plastic shutters) - 3 years
5. Poultry feeder pans that become unusable within five years from the date of installation - Warranty prorated after three years usage
6. Rotating centerless augers, excluding applications involving high moisture feed stuffs (exceeding 18%), for ten years from the date of installation. Note: MULTIFLO® and applications involving high moisture feed stuffs are subject to a one-year warranty
7. Chore-Time manufactured roll-formed steel auger tubes for ten years from the date of installation
8. ULTRAFLO® Breeder Feeding System auger and feed trough are warranted for a period of five years from the date of original installation against repeated breakage of the auger or wear-through of the feed trough caused solely by the auger
9. ULTRAPAN® Feeding System augers are warranted for a period of five years from the date of installation

## CONDITIONS AND LIMITATIONS

1. The product must be installed by and operated in accordance with the instructions published by the Manufacturer or Warranty will be void.
2. Warranty is void if all components of the system are not original equipment supplied by the Manufacturer.
3. This product must be purchased from and installed by an authorized distributor or certified representative thereof or the Warranty will be void.
4. Malfunctions or failure resulting from misuse, abuse, negligence, alteration, accident, or lack of proper maintenance shall not be considered defects under the Warranty.
5. This Warranty applies only to systems for the care of poultry and livestock. Other applications in industry or commerce are not covered by this Warranty.

Chore-Time shall not be liable for any consequential or special damage which any purchaser may suffer or claim to suffer as a result of any defect in the product. "Consequential" or special damages" as used herein include, but are not limited to, lost or damaged products or goods, costs of transportation, lost sales, lost orders, lost income, increased overhead, labor and incidental costs and operational inefficiencies.

THIS WARRANTY CONSTITUTES THE MANUFACTURER'S ENTIRE AND SOLE WARRANTY AND THIS MANUFACTURER DISCLAIMS ANY AND ALL OTHER WARRANTIES, INCLUDING, BUT NOT LIMITED TO, EXPRESS AND IMPLIED WARRANTIES AS TO MERCHANTABILITY, FITNESS FOR PARTICULAR PURPOSES SOLD AND DESCRIPTION OR QUALITY OF THE PRODUCT FURNISHED HEREUNDER.

Chore-Time Distributors are not authorized to modify or extend the terms and conditions of this Warranty in any manner or to offer or grant any other warranties for Chore-Time products in addition to those terms expressly stated above.

An officer of CTB, Inc. must authorize any exceptions to this Warranty in writing. Chore-Time reserves the right to change models and specifications at any time without notice or obligation to improve previous models.

Effective: **July 2004**

**Chore-Time Poultry Production Systems**  
**A division of CTB, Inc.**  
**410 N. Higbee Street • Milford, Indiana 46542 • U.S.A.**  
**Phone (574) 658-4101 • Fax (877) 730-8825**  
**E-mail: [ctb@ctbinc.com](mailto:ctb@ctbinc.com) • Internet: [www.choretimepoultry.com](http://www.choretimepoultry.com)**

### Thank You

The employees of Chore-Time would like to thank your for your recent Chore-Time purchase. If a problem should arise, your Chore-Time distributor can supply the necessary information to help you.

### **\*Chore-Time Poultry Feeder Pan Pro Rata Schedule**

Year from date of installation during which pan becomes unusable	Charge to be paid by the purchaser for replacement.
0 - 1 years	NO CHARGE
1 - 2 years	NO CHARGE
2 - 3 years	NO CHARGE
3 - 4 years	4/10 of then current list price
4 - 5 years	5/10 of then current list price

# Contents

Topic	Page
<b>Chore-Time Warranty</b> .....	<b>2</b>
CONDITIONS AND LIMITATIONS .....	3
<b>About This Manual</b> .....	<b>7</b>
<b>Safety Information</b> .....	<b>7</b>
<b>Safety Instructions</b> .....	<b>8</b>
Follow Safety Instructions .....	8
Decal Descriptions .....	8
DANGER: Moving Auger .....	8
DANGER: Electrical Hazard .....	8
CAUTION: .....	8
<b>Selected CTB Licensed Trademarks and Trade Name Reference</b> .....	<b>9</b>
<b>Livestock and Poultry Feed Consumption</b> .....	<b>10</b>
Poultry .....	10
Hogs .....	10
Dairy .....	10
<b>Fill System Power Unit Selection Guide</b> .....	<b>11</b>
<b>FLEX-AUGER® System</b> .....	<b>12</b>
System Information .....	12
MODEL 55, 75, 90, HMC, and 108 FLEX-AUGER® Fill Systems (Standard) .....	12
Extended Length Models 55 through 108 Systems .....	12
Boots .....	12
Tandem Bin Systems .....	12
Feed Level Controls .....	12
Time Control .....	12
High-Moisture Applications .....	12
Feed Delivery Rates .....	12
<b>FLEX-AUGER®</b> .....	<b>13</b>
System Specifications .....	13
Horse Power Requirements .....	13
Straight-Thru Tandem .....	15
MODEL 108 Boot and Baffle .....	16
Two-Motor Tandem Systems .....	17
Boot Accessories .....	18
Boot Slides .....	19
FLEX-AUGER® Boot Assembly .....	20
Extension Hoppers .....	22
Model 55, 75, 90, 108 .....	22
Model 108 Extension Boot Kit .....	22
FLAG Extension Boot .....	22
30 Degree Two Motor Tandem Boots .....	22
Auger, Bearing Assemblies, Driver Assemblies .....	23
Augers .....	23
Non-Restricted Anchor Bearing Assembly .....	23
Restricted Anchor Bearing Assembly .....	23
Cap Assembly .....	23
Bearing Assembly .....	23
Bearing Safety Cap .....	23
Driver Assembly .....	23

FLEX-AUGER® Tubes and Elbows (Including connectors and clamp kits) . . . . .	24
Outlet Drops and Accessories . . . . .	25
Control Units . . . . .	26
Bin Fill Cap Kits. . . . .	27
Intermediate fill cap kits . . . . .	27
Terminal bin fill cap kits . . . . .	27
Model 108 Bin-to-Bin fill cap kits . . . . .	28
Power Units . . . . .	29
Switches and Timers. . . . .	30
Hopper Level Switches . . . . .	30
Proximity Drop Tube Switches . . . . .	30
Control Level Switches . . . . .	30
Boot Switches . . . . .	30
Sleeve Switch MULTIFLO® . . . . .	30
Contactor Box . . . . .	30
Time Clock . . . . .	30
Auger Timer . . . . .	30
Delay Relays . . . . .	30
Drop Feeder Control . . . . .	31
Interval Timer . . . . .	31
Misc. . . . .	31
Single Contactors . . . . .	31
<b>MULTIFLO® System . . . . .</b>	<b>33</b>
Information . . . . .	33
General Information . . . . .	33
The Fill System . . . . .	33
The MULTIFLO® Boot . . . . .	33
Tube and Elbows . . . . .	33
Power Unit(s) . . . . .	33
Control Switch . . . . .	33
Component Parts . . . . .	33
Accessories . . . . .	33
<b>Planning the MULTIFLO® System . . . . .</b>	<b>34</b>
MULTIFLO® Boot Placement . . . . .	34
Determine Where to Install Power Units . . . . .	34
Outlet Drop Size and Placement . . . . .	34
Examples of MULTIFLO® System Layout . . . . .	35
<b>MULTIFLO® SPECIFICATIONS . . . . .</b>	<b>37</b>
Auger Information . . . . .	37
Auger Specifications . . . . .	37
MULTIFLO® Effective Length Calculation . . . . .	38
Example with 90° Elbow: . . . . .	38
Example with 180° Elbow: . . . . .	38
<b>MULTIFLO® Components . . . . .</b>	<b>39</b>
Drive Units . . . . .	39
MULTIFLO® Elbows . . . . .	40
MULTIFLO® PVC Tubing and Auger . . . . .	40
<b>FLAG™ System . . . . .</b>	<b>42</b>
System information . . . . .	42
General information . . . . .	42
Specifications . . . . .	42
The Fill System . . . . .	42
Transfer boot and switch . . . . .	42
Auger . . . . .	42
Controls . . . . .	42

FLAG™ line power unit selection guide . . . . .	42
<b>FLAG™ System Layouts . . . . .</b>	<b>43</b>
Standard FLAG™ System Layout . . . . .	43
Alternate Layout FLAG™ Return Fill System Layout . . . . .	43
Alternate Layout Twin Boot FLAG™ System Layout . . . . .	44
Alternate Layout FLAG™ Circulating Fill System Layout . . . . .	44
<b>FLAG™ System Boot Options . . . . .</b>	<b>45</b>
Terminal Boot . . . . .	45
Transfer Boot . . . . .	45
Transfer Boot with Proximity Switch . . . . .	45
Center Twin Transfer Boot . . . . .	45
Center Twin Terminal Boot . . . . .	45
Extension Boot . . . . .	45
<b>Drop Feeding System . . . . .</b>	<b>47</b>
System Information . . . . .	47
The Feed Delivery System . . . . .	47
Drop Feeders and Drop Feeder Control Units . . . . .	47
Feeding Control Options . . . . .	47
Drop Tubes . . . . .	47
Cable . . . . .	47
<b>Drop Feeding System Layouts . . . . .</b>	<b>48</b>
Linear Actuator Installations . . . . .	48
Drop Feeding system layout . . . . .	48
Drop Feeding System Layout Using Multiple Linear Actuators . . . . .	49
Drop Feeding System Layout Using Multiple Linear Actuators . . . . .	49
<b>Drop Feeding System Components . . . . .</b>	<b>50</b>
Drop Tube and Mount Kits . . . . .	50
Drop Feeder Actuator . . . . .	51
Drop Feeders . . . . .	52
Farrowing Drop . . . . .	52
Drop Feeder Control Units . . . . .	53
<b>Suspension Components . . . . .</b>	<b>54</b>

## About This Manual

The intent of this manual is to help you in two ways. One is to follow step-by-step in the order of assembly of your product. The other way is for easy reference if you have questions in a particular area.

**Important: Read ALL instructions carefully before starting construction.**

**Important: Pay particular attention to all SAFETY information.**

- *Metric measurements are shown in millimeters and in brackets, unless otherwise specified. “ ” equals inches and “' ” equals feet in English measurements.*

*Examples:*

*1" [25.4]*

*4' [1 219]*

- Optional equipment contains necessary instructions for assembly or operation.
- Very small numbers near an illustration (*i.e.*, 1257-48) are identification of the graphic, not a part number.

Note: The original, authoritative version of this manual is the English version produced by CTB, Inc. or any of its subsidiaries or divisions, (hereafter collectively referred to as "CTB"). Subsequent changes to any manual made by any third party have not been reviewed nor authenticated by CTB. Such changes may include, but are not limited to, translation into languages other than English, and additions to or deletions from the original content. CTB disclaims responsibility for any and all damages, injuries, warranty claims and/or any other claims associated with such changes, inasmuch as such changes result in content that is different from the authoritative CTB-published English version of the manual. For current product installation and operation information, please contact the customer service and/or technical service departments of the appropriate CTB subsidiary or division. Should you observe any questionable content in any manual, please notify CTB immediately in writing to: CTB Legal Department, P.O. Box 2000, Milford, IN 46542-2000 USA.

## Safety Information

**Caution, Warning and Danger Decals** have been placed on the equipment to warn of potentially dangerous situations. Care should be taken to keep this information intact and easy to read at all times. Replace missing or damaged safety decals immediately.

Using the equipment for purposes other than specified in this manual may cause personal injury and/or damage to the equipment.

### Safety–Alert Symbol



**This is a safety–alert symbol.** When you see this symbol on your equipment, be alert to the potential for personal injury. This equipment is designed to be installed and operated as safely as possible...however, hazards do exist.

### Understanding Signal Words

**Signal words** are used in conjunction with the safety–alert symbol to identify the severity of the warning.



**DANGER** indicates an imminently hazardous situation which, if not avoided, **WILL** result in death or serious injury.



**WARNING** indicates a potentially hazardous situation which, if not avoided, **COULD** result in death or serious injury.



**CAUTION** indicates a hazardous situation which, if not avoided, **MAY** result in minor or moderate injury.

## Safety Instructions

### Follow Safety Instructions

Carefully read all safety messages in this manual and on your equipment safety signs. Follow recommended precautions and safe operating practices.

Keep safety signs in good condition. Replace missing or damaged safety signs.

### Decal Descriptions

#### **DANGER: Moving Auger**

This decal is placed on the Panel Weldment.

Severe personal injury will result, if the electrical power is not disconnected, prior to servicing the equipment.

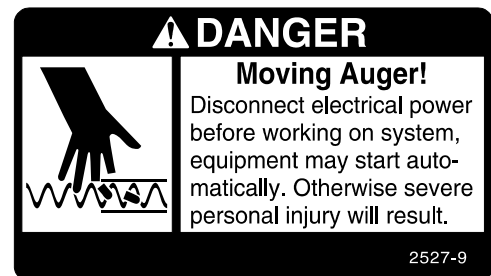

#### **DANGER: Electrical Hazard**

Disconnect electrical power before inspecting or servicing equipment unless maintenance instructions specifically state otherwise.

Ground all electrical equipment for safety.

All electrical wiring must be done by a qualified electrician in accordance with local and national electric codes.

Ground all non-current carrying metal parts to guard against electrical shock.

With the exception of motor overload protection, electrical disconnects and over current protection are not supplied with the equipment.

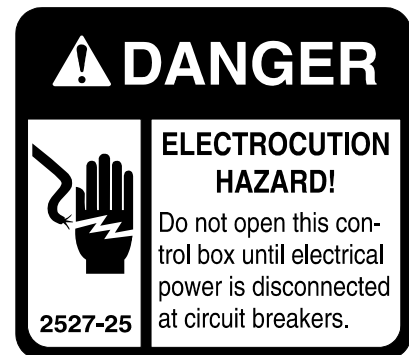

#### **CAUTION:**

Use caution when working with the Auger—springing Auger may cause personal injury.

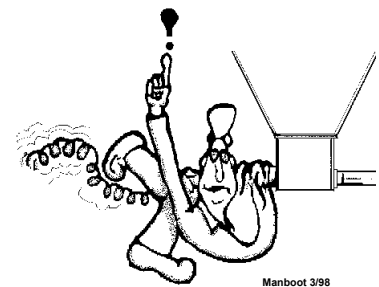



## Selected CTB Licensed Trademarks and Trade Name Reference

This Reference Book contains references to certain registered trademarks, trademarks or service marks of CTB, Inc. and/or CTB IP, Inc. Please reference this page for the most up-to-date and appropriate spelling, capitalization, hyphenation and symbol (®,™,or<sup>SM</sup>) to be used with each

The absence of a registered trademark, trademark, service mark or logo from this list does not constitute a waiver of CTB's trademark or other intellectual property rights concerning that mark or logo.

<b>ACCU-CLICK™</b>	<b>MULTI-LIFT®</b>
<b>ACCUTROL®</b>	<b>MULTI-MODEL™</b>
<b>AGRI-TIME &amp; DESIGN®</b>	<b>MULITFLO®</b>
<b>ALL-OUT®</b>	<b>PDS™</b>
<b>C-CENTRAL™</b>	<b>PRODUCT LEADERSHIP™</b>
<b>C-COLLECT®</b>	<b>RELIA-FLOW®</b>
<b>CHORE-TIME &amp; DESIGN®</b>	<b>REVOLUTION®</b>
<b>CHORE-TIME®</b>	<b>RLX™</b>
<b>CHORE-TRONICS &amp; DESIGN®</b>	<b>SENSOR PLUS™</b>
<b>CHORE-TRONICS®</b>	<b>SHAKER-PLATE®</b>
<b>CTB &amp; DESIGN®</b>	<b>SHUR-LOCK®</b>
<b>CTB®</b>	<b>SMART<sup>SM</sup></b>
<b>DURA-THERM™</b>	<b>SNAP-TOP™</b>
<b>E-Z START®</b>	<b>SUPER 6™</b>
<b>FLEX AUGER &amp; DESIGN®</b>	<b>SUPER-LIFT™</b>
<b>FLEX-AUGER®</b>	<b>SUPER-SELECTOR®</b>
<b>HYFLO®</b>	<b>SUPER-VISOR®</b>
<b>LEADERSHIP THROUGH INNOVATION®</b>	<b>TURBO-COOL™</b>
<b>LINEAR-LIFT™</b>	<b>TURBO®</b>
<b>MADE TO WORK. BUILT TO LAST.®</b>	<b>ULTRA-HP™</b>
<b>MEAL-TIME™</b>	<b>ULTRA-JET™</b>
<b>MODEL 2000™</b>	<b>ULTRA-RAY®</b>
<b>MODEL ATF™</b>	<b>ULTRA-RAY® HI-BEAM</b>
<b>MODEL ATF™ PLUS</b>	<b>ULTRA-RAY® LITE-BEAM</b>
<b>MODEL C2M™</b>	<b>ULTRA-RAY® PLUS</b>
<b>MODEL C2®</b>	<b>ULTRA-VECTION™</b>
<b>MODEL C2® PLUS</b>	<b>ULTRAFLO®</b>
<b>MODEL C™</b>	<b>ULTRAPAN®</b>
<b>MODEL G™</b>	<b>VANGUARD™</b>
<b>MODEL G™ PLUS</b>	<b>VANGUARD™ PLUS</b>
<b>MODEL H2™</b>	<b>VOLUMATIC™</b>
<b>MODEL H2™ PLUS</b>	<b>WEIGH-MATIC®</b>

# Livestock and Poultry Feed Consumption

## Poultry

Poultry applications use automatic feeding systems sized for the building density. The FLEX-AUGER® feed delivery system’s delivery rate should be sized to match or exceed the sum of the delivery rates of the automatic feeders supplied.

### CHORE-TIME® Floor Feeding System

### Delivery Rates

MODEL C2, C2 PLUS, H2, H2 PLUS, G and G PLUS with 216 RPM Power Unit	10.8 lbs or 4.89 kg/min.*
MODEL C2, C2 PLUS, H2, H2 PLUS, G and G PLUS with 348 RPM Power Unit	17.0 lbs or 7.71 kg/min.*
MODEL ATF	18.0 lbs or 8.16 kg/min.*
Pan Breeder Feeder System	35.0 lbs or 15.87 kg/min.*
ULTRAFLO Breeder Feeder (per Hopper)	52.0 lbs or 23.58 kg/min.*
ULTRAPAN Feeding System (per Hopper)	50.0 lbs or 22.68 kg/min.*

\*Based on 40lbs/ft<sup>3</sup> density (64 kg/m<sup>3</sup>)

## Hogs

### Live weight-lbs/Hog

### Total Average Daily Feed-lbs/Head

10-25 (4.5-11.3 kg)	1.2 (.54 kg)
25-50 (11.3-22.7 kg)	2.5 (1.13 kg)
50-75 (22.7-34 kg)	4.0 (1.81 kg)
75-125 (34-56.7 kg)	5.2 (2.35 kg)
125-175 (56.7-79.4 kg)	6.7 (3.04 kg)
175-225 (79.4-102 kg)	7.8 (3.54 kg)
Gestating Sows	5.0 (2.26 kg)

## Dairy

### Milk/Cow/Day-lbs Average

### Concentrates\*/Cow/Day-lbs Average

30 (13.61 kg)	10 (4.53 kg)
50 (22.68 kg)	20 (9.07 kg)
70 (31.75 kg)	30 (13.61 kg)
80 (36.28 kg)	40 (18.14 kg)

TO DETERMINE THE RUNNING TIME PER DAY - Multiply the number of animals by the feed consumption/ head (figures from the charts) to get total feed consumption.

Divide total feed consumption by the stated delivery rate of the FLEX-AUGER feed delivery system to get running time per day in minutes. Divide this by 60 to get running time per day in hours.

# Fill System Power Unit Selection Guide

<b>230 V, 60 Hz, Single Phase Power Units</b>						
<b>Model 75 Fill System</b>				<b>Model 90 Fill System</b>		
<b>No. of FLAG™ Lines</b>	<b>348 RPM Maximum Length</b>			<b>348 RPM Maximum Length</b>		
	<b>80' [24 m]</b>	<b>150' [46 m]</b>	<b>200' [61 m]</b>	<b>30' [9 m]</b>	<b>90' [27 m]</b>	<b>150' [46 m]</b>
2	3259-51	3259-52	3259-49	---	---	---
3	3259-51	3259-52	3259-49	---	---	---
4	3259-51	3259-52	3259-49	---	---	---
5	---	---	---	3259-51	3259-52	3259-49
6	---	---	---	3259-51	3259-52	3259-49

<b>230/460 V, 60 Hz, Three Phase Power Units</b>						
<b>Model 75 Fill System</b>				<b>Model 90 Fill System</b>		
<b>No. of FLAG™ Lines</b>	<b>348 RPM Maximum Length</b>			<b>348 RPM Maximum Length</b>		
	<b>80' [24 m]</b>	<b>150' [46 m]</b>	<b>200' [61 m]</b>	<b>30' [9 m]</b>	<b>90' [27 m]</b>	<b>150' [46 m]</b>
2	3259-119	3259-119	3259-117	---	---	---
3	3259-119	3259-119	3259-117	---	---	---
4	3259-119	3259-119	3259-117	---	---	---
5	---	---	---	3259-119	3259-119	3259-117
6	---	---	---	3259-119	3259-119	3259-117

<b>220 V, 50 Hz, Single Phase Power Units</b>						
<b>Model 75 Fill System</b>				<b>Model 90 Fill System</b>		
<b>No. of FLAG™ Lines</b>	<b>348 RPM Maximum Length</b>			<b>348 RPM Maximum Length</b>		
	<b>80' [24 m]</b>	<b>150' [46 m]</b>	<b>200' [61 m]</b>	<b>30' [9 m]</b>	<b>90' [27 m]</b>	<b>150' [46 m]</b>
2	3259-88	3259-88	3259-89	---	---	---
3	3259-88	3259-88	3259-89	---	---	---
4	3259-88	3259-88	3259-89	---	---	---
5	---	---	---	3259-87	3259-88	3259-89
6	---	---	---	3259-87	3259-88	3259-89

<b>220/380 V, 50 Hz, Three Phase Power Units</b>						
<b>Model 75 Fill System</b>				<b>Model 90 Fill System</b>		
<b>No. of FLAG™ Lines</b>	<b>348 RPM Maximum Length</b>			<b>348 RPM Maximum Length</b>		
	<b>80' [24 m]</b>	<b>150' [46 m]</b>	<b>200' [61 m]</b>	<b>30' [9 m]</b>	<b>90' [27 m]</b>	<b>150' [46 m]</b>
2	3259-103	3259-104	3259-105	---	---	---
3	3259-103	3259-104	3259-105	---	---	---
4	3259-103	3259-104	3259-105	---	---	---
5	---	---	---	3259-103	3259-104	3259-105
6	---	---	---	3259-103	3259-104	3259-105

# FLEX-AUGER® System

## System Information

### MODEL 55, 75, 90, HMC, and 108 FLEX-AUGER® Fill Systems (Standard)

All standard fill systems include enough components for horizontal length indicated. This is dimension “A” on the chart. For example: a 40’ [12 m] length, order a Model 55, 75, 90, HMC, or 108-40 system. All standard systems, as referred to in system price assume use of a 30 degree boot (not included), and include a 348 rpm power unit, control unit, hopper level control, elbows, PVC tube, PVC cement, suspension kits, contactor (if needed) and auger adequate for a 45 degree incline, rising to a 9’ [2.7 m] elevation.

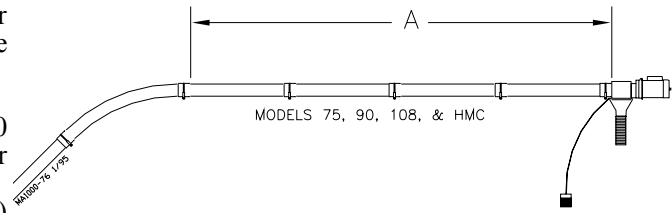

Models 55 through 108 systems utilize 5’ [1.5 m] radius elbows requiring the bin to be centered 12’ [3.7 m] from the building. Adequate elbows are supplied for closer bin placement to a maximum of 60 degree incline (utilizing 30 degree boot).

For each additional 45 degree elbow ordered for Model 55-108 systems, 5’ [1.5 m] additional auger is required. On all systems, for each 90 degree of additional elbow, decrease maximum line length for each power unit size by 30’ [9 m].

### Extended Length Models 55 through 108 Systems

The extended length systems are supplied with adequate components to complete the system; including extension boot, 348 rpm power unit, PVC tube, PVC cement, suspension kits, and auger. Extended length systems require direct drive power units.

### Boots

Select the correct boot for the system(s). All boots are shipped without a switch. If a switch is desired see component listing. Straight-out boots require 5’ [1.5 m] additional auger and decrease maximum line length for each power unit size by 30’ [9 m].

### Tandem Bin Systems

Where extra feed storage, or dual rations are required, CHORE-TIME recommends the straight-through tandem system, or 90 degree two motor tandem system. Tandem systems are available on Models 75, 90, HMC, & 108 systems. For each straight-through tandem system (75, 90, HMC, & 108), decrease maximum line length for each power unit size by 50’ [15 m].

### Feed Level Controls

Select the proper feed level control for the application. The control unit does have a safety switch. This switch is **ONLY** a back-up and **MUST** have a feed level control used with it.

### Time Control

**A timing device is recommended for all systems**--set for slightly longer than normal running time. This will prevent excess operation with an empty auger and also protect against other malfunctions. See control listing for options such as the auger/safety timer.

### High-Moisture Applications

The Model HMC and 108 systems can be used to convey higher moisture content feeds. **THE SYSTEM IS NOT TO BE USED TO CONVEY ANY PRODUCT ABOVE 27% MOISTURE!** Warranty on a system used to convey high-moisture feeds (feeds of 18-27% moisture content) is one year for the date of installation.

### Feed Delivery Rates

The FLEX-AUGER® feed delivery systems have different delivery rates that should be matched to the requirements of the application. The system should be sized so the **MAXIMUM** operating time is four hours per day (24 hours).

**TO DETERMINE THE OPERATION TIME PER DAY:** Multiply the number of animals by the feed consumption/head figures to get total feed consumption. Divide the total feed consumption by the stated delivery rate of the selected FLEX-AUGER delivery system to get operation time per day in minutes. Divide this by 60 to get the operation time per day in hours.

# FLEX-AUGER®

## System Specifications

System	Tube Diameter	Delivery Rate*	Feed Type	Max. Particle Size
MODEL 55	2-1/4" (55 mm)	15 lb/min (7 kg/min)	Mash, crumbles 18% moist. content	5/32" x 1/2" (4 mm x 13 mm)
MODEL 75	3" (75 mm)	50 lb/min (22 kg/min)	Mash, crumbles 18% moist. content	5/32" x 1/2" (4 mm x 13 mm)
MODEL 90	3-1/2" (90 mm)	100 lb/min (45 kg/min)	Mash, pellets, shelled corn 18% moist. content	3/16" x 1/2" (5 mm x 13 mm)
MODEL 108	4-1/2" (108 mm)	220 lb/min (100 kg/min)	High-moisture corn, small pellets, crumbles, mash 27% moist. content	3/16" x 1/2" (5 mm x 13 mm)
MODEL HMC	3-1/2" (90 mm)	50 lb/min (22 kg/min)	High-moisture corn, large pellets, crumbles, mash 27% moist. content	3/8" x 3/4" (10 mm x 20 mm)

\*Conveying capacity is based on feed with 40 pounds per cubic foot (640 kg. per cubic meter) density. Conveying capacities for all FLEX-AUGER® systems are determined using 348 RPM power units.

## Horse Power Requirements

Horse power requirements are based on length of the FLEX-AUGER® systems and type of system installed, number of turns, tandem systems, etc. The charts included show maximum line lengths for FLEX-AUGER systems plus maximum lengths for systems using extension hoppers.

**Note: Line length should be reduced by 20% for use on 208 volt 60 Hz.**

MODEL 55			MODEL 90		
Motor H.P	Maximum Line Length	Maximum Extension	Motor H.P	Maximum Line Length	Maximum Extension
1/3	150' (46 m)	185' (56 m)	1/2	30' (9 m)	65' (20 m)
1/2	250' (76 m)	286' (87 m)	3/4	90' (27 m)	125' (38 m)
			1	150' (46 m)	185' (56 m)
MODEL 75			MODEL 108		
Motor H.P	Maximum Line Length	Maximum Extension	Motor H.P	Maximum Line Length	Maximum Extension
1/2	80' (24 m)	125' (38 m)	3/4	50' (15 m)	75' (23 m)
3/4	150' (46 m)	185' (56 m)	1	100' (31 m)	135' (41 m)
1	200' (61 m)	245' (75 m)	1-1/2	150' (46 m)	185' (56 m)
MODEL HMC			MODEL 108 HI Capacity		
Motor H.P	Maximum Line Length	Maximum Extension	Motor H.P	Maximum Line Length	Maximum Extension
1/2	30' (9 m)	55' (17 m)	1	50' (15 m)	75' (23 m)
3/4	90' (27 m)	105' (32 m)	1-1/2	100' (315 m)	135' (41 m)
1	150' (46 m)	185' (56 m)	2	150' (46 m)	185' (56 m)

This layout shows a 30 degree boot installation with one extension hopper and Flex auger control unit. The outlet drops show, drop tube with telescoping drop tube to allow the raising and lowering of the feed hoppers.

This layout may be used on Model 555, 75, 90, HMC & 108

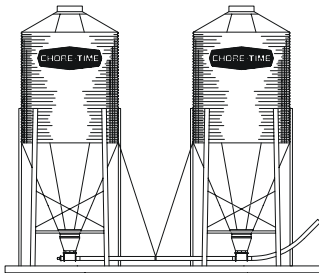
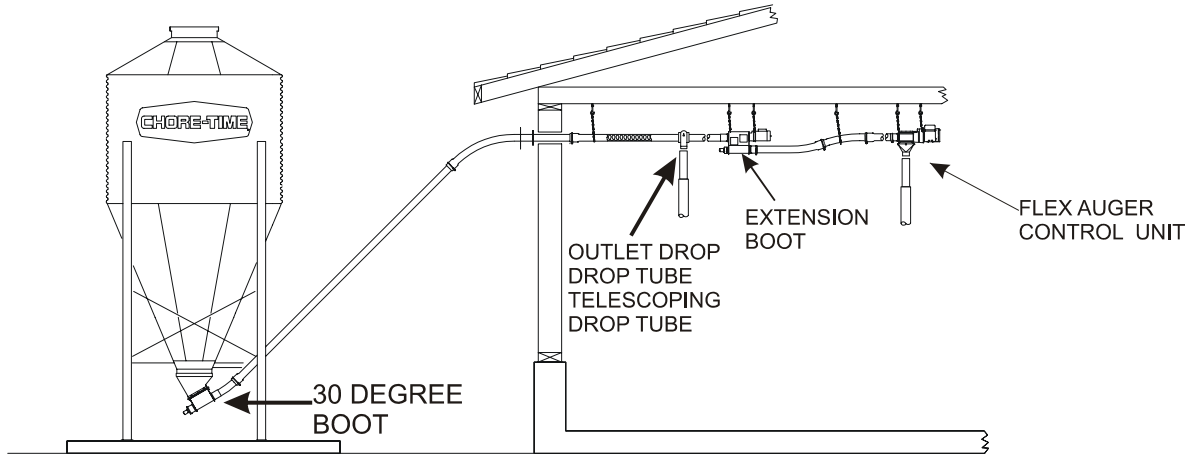

The layout at the left shows two feed bins with a straight through tandem . The auger passes through the intermediate bin allowing the feed to be pulled from either bin. Slides should not be pulled out of both bins, this could cause the auger to overload.

This layout may be used on Model 75, 90, HMC & 108

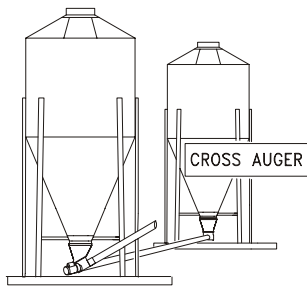

The 30 Degree Two Motor Tandem System to the left uses a motor to pull from the terminal bin into the intermediate bin.

This layout may be used on Model 75, 90, HMC

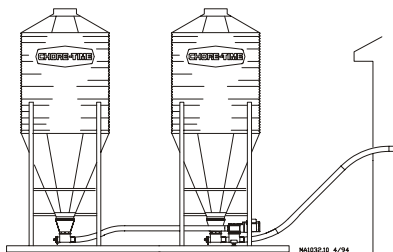

TWO MOTOR TANDEM SYSTEM MODEL 108

LAYOUT.CDR

# Straight-Thru Tandem

**Model 75 Single Straight-Through System** →

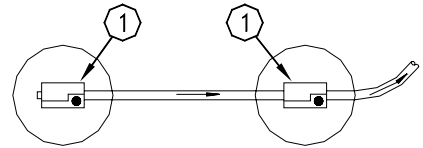

**Model 90 and HMC Single Straight-Through System** →

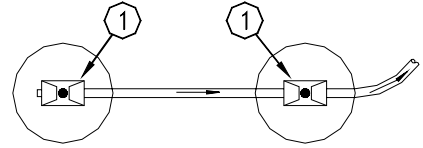

**Model 75 Combination Single-Twin Straight Through System** →

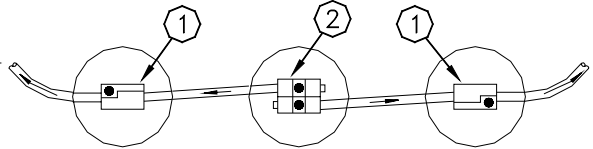

**Model 90 Combination Single-Twin Straight Through System** →

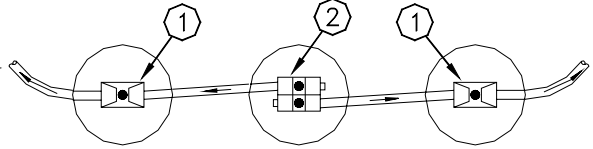

**Model 75, 90, or HMC Twin Straight-Through System** →

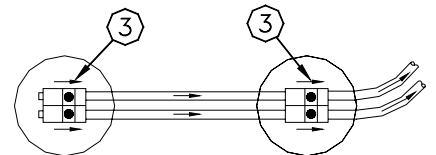

**Model 75, 90, or HMC Twin Straight-Through System** →

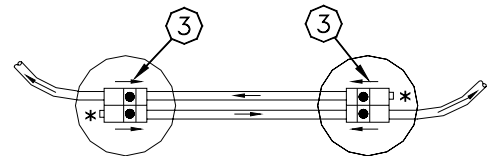

**Model 75, 90, or HMC Twin Straight-Through System** →

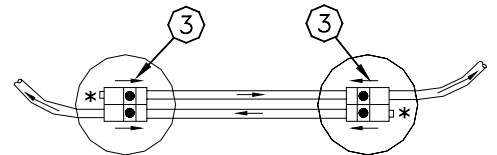

**Model 90 Three Bin System Twin Straight-Through System** →

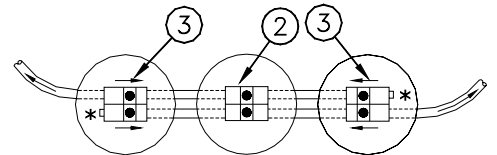

**Model 90 Three Bin System Twin Straight-Through System** →

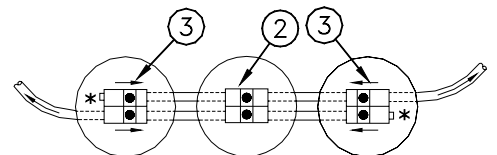

Key	Description
1	Single Baffled Boot
2	Twin Baffled Boot (Model 75 or 90) Mount Either Direction
3	Arrow Tape

**\*Note:** On twin systems running in opposite directions, follow the tape on the bearing end of the system.

MA1000-127 2/04

### MODEL 108 Boot and Baffle

STANDARD  
AS SHIPPED

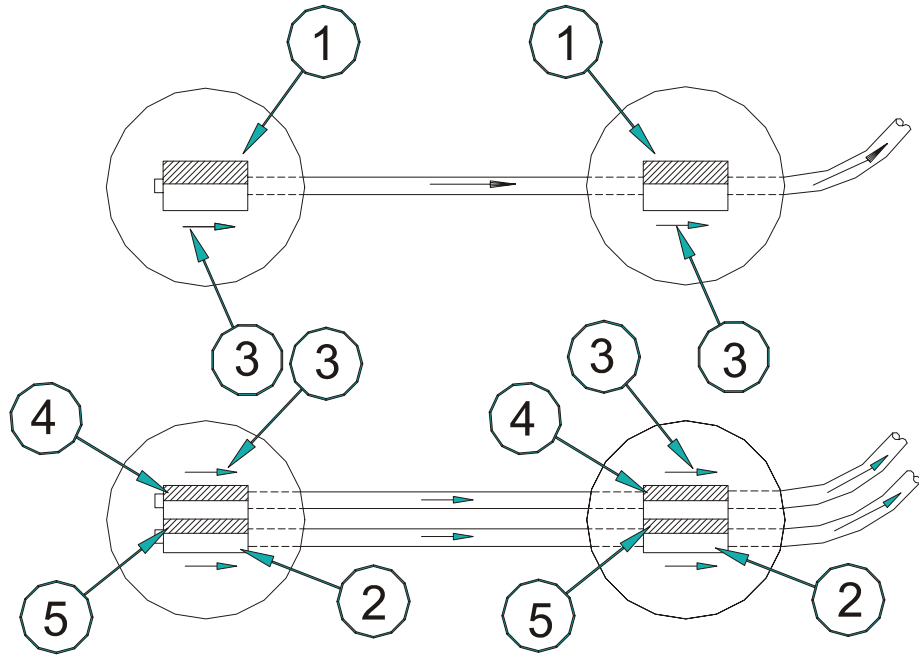

MUST ORDER  
(2) 35624

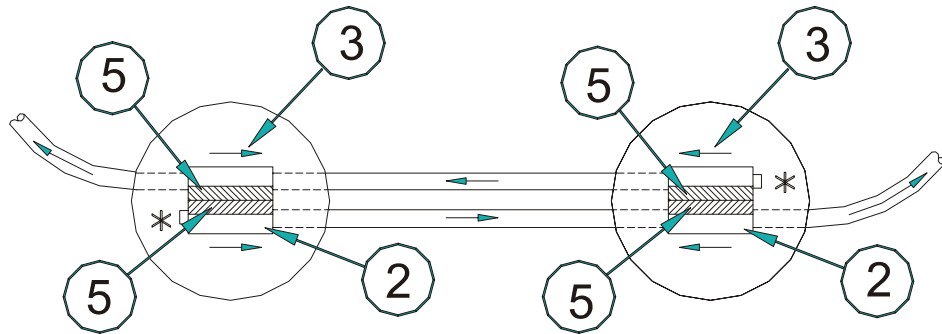

MUST ORDER  
(2) 35615

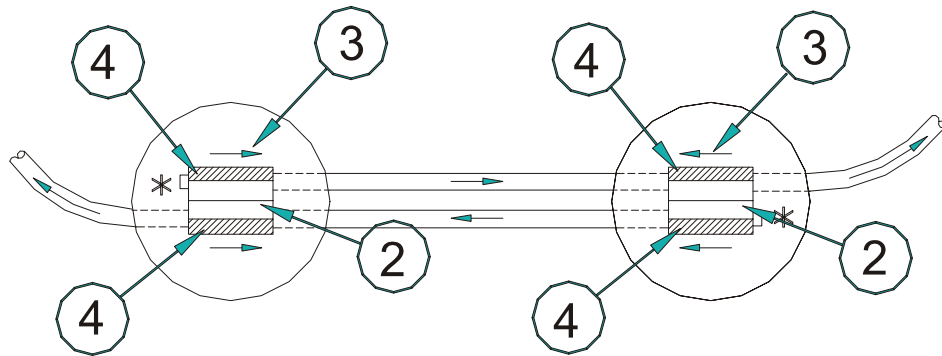

KEY	DESCRIPTION
1	SINGLE BAFFLED BOOT
2	TWIN BAFFLED BOOT
3	ARROW TAPE
4	35615 CLEAN-OUT WELDMENT
5	35624 CENTER BAFFLE PLATE

\* INDICATES BEARING END

PLAN#2.CDR



## Two-Motor Tandem Systems

30 DEGREE TWO-MOTOR TANDEM

AVAILABLE IN MODEL 75, 90 AND HMC

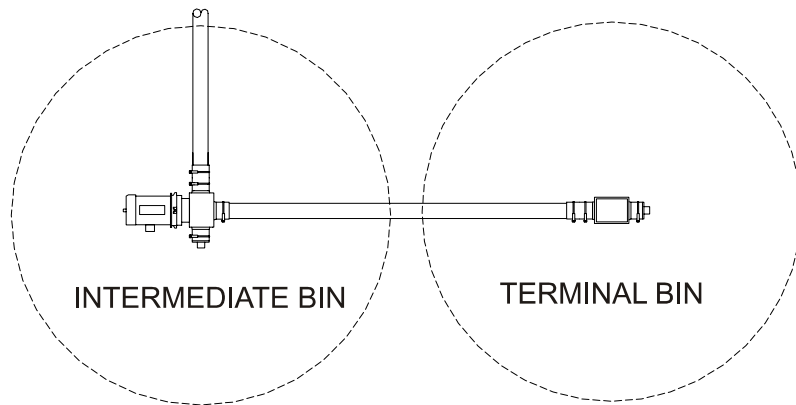

MODEL 108 TWO-MOTOR TANDEM

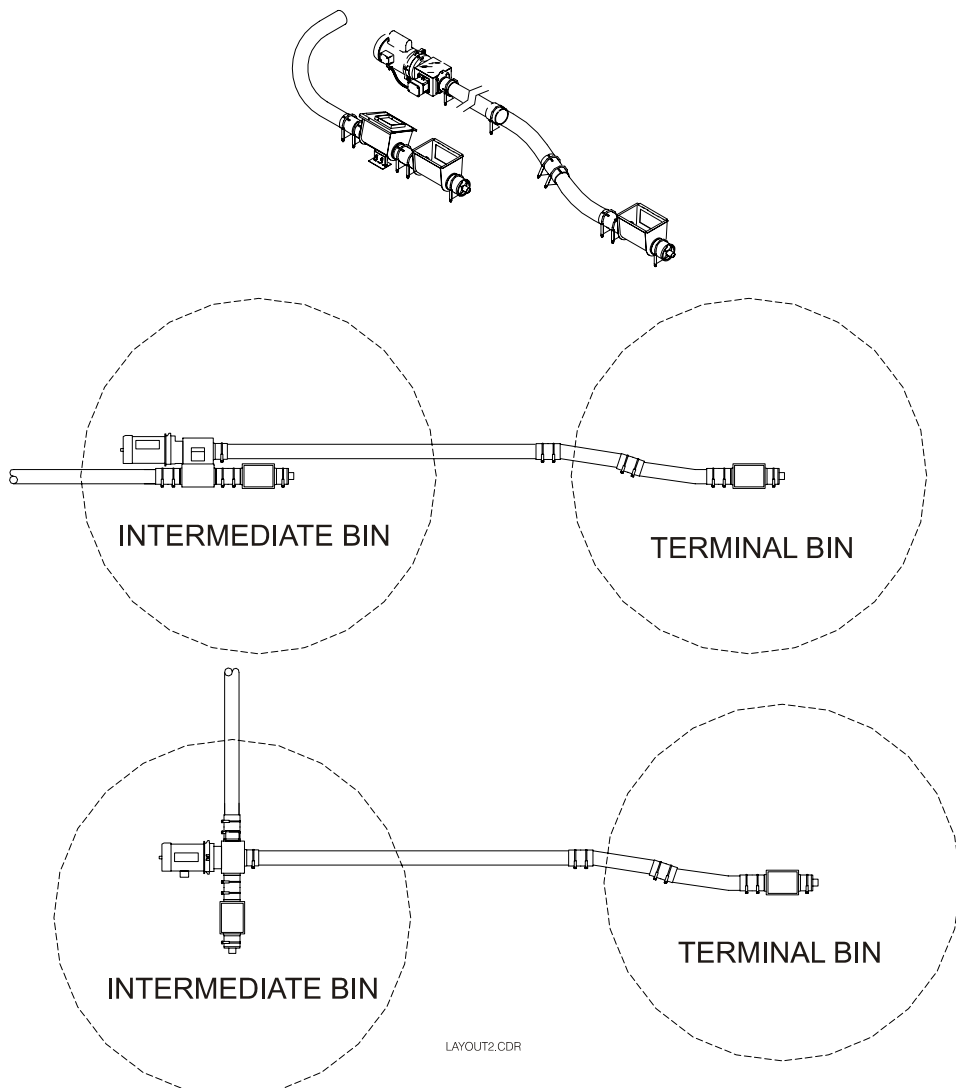

LAYOUT2.CDR

## Boot Accessories

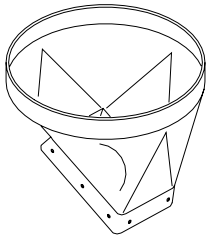

Upper boot straight out. The upper boot provides a transfer from the bin to the lower boot.

\*6093R is a Straight-Out Boot (Red)

\*6093C is a Straight-Out Boot (Clear)

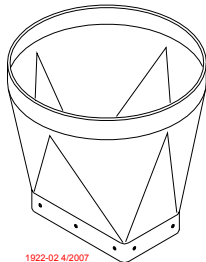

The upper boot provides a transfer from the bin to the lower boot.

\*4347R is a 30 Degree Boot (Red)

\*4347C is a 30 Degree Boot (Clear)

1922-02 4/2007

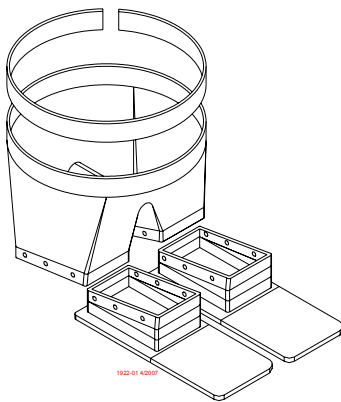

Twin boot assembly: 03102308 Includes: Upper boot with collar shim, (2) slide and transfer plates.

Use with 3-32467 reinforced collar (7' 67° Bin)

Use with 3-32466 reinforced collar (9' 60° Bin)

1922-01 4/2007

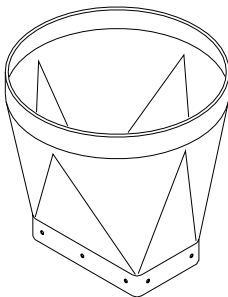

Clean out valve kit: 13722

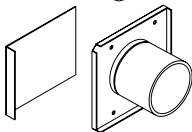

1922-03 4/2007

Optional Boot Slide: 43755SS-50

This slide is made of Stainless Steel and can be used in the 6284 slide and transfer kit.

If ordering 4357SS-50 it should be noted that an order of quantity (1) will result in 50 slides.

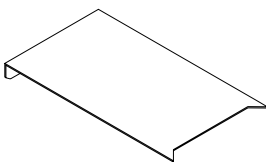

1922-20 4/2007

# Boot Slides

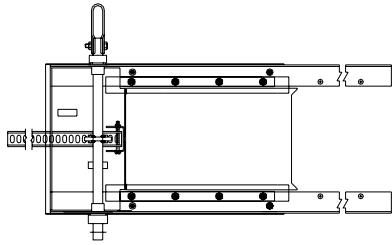

Single manual slide agitator: 46934

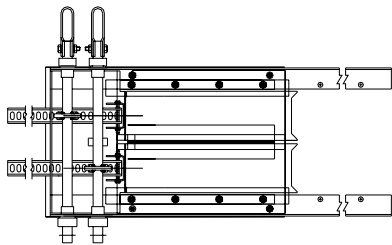

Twin manual slide agitator: 46935

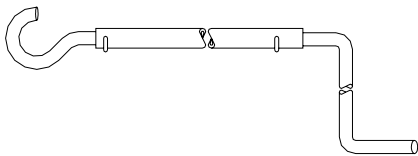

Telescoping drive handle: 47638

Telescopes from 5' to 8'

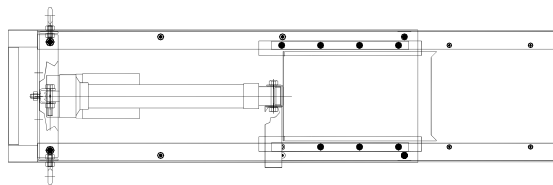
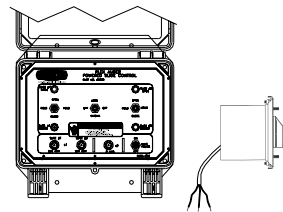

Single tandem auto slide kit: 47578

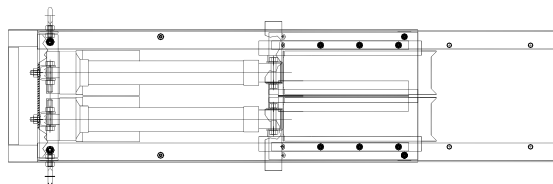
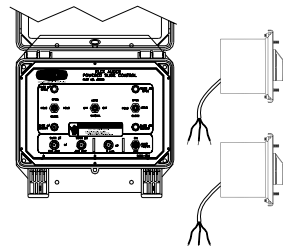

Twin tandem auto slide kit: 47580

1922-05 4/2007

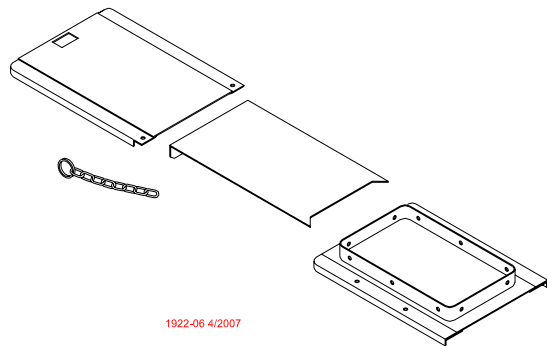

1922-06 4/2007

Single slide and transfer kit: 6284. Used on all single and 30° twin boots.

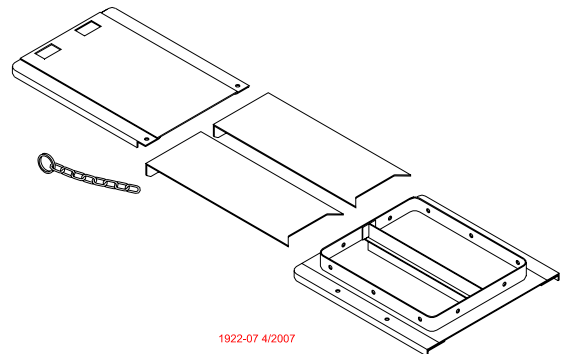

1922-07 4/2007

Twin slide and transfer kit: 36683. Used on Model 75, 90, HMC, and straight out twin boots.

\*Model 55 quad boot assembly uses 36093 shut off slide.

# FLEX-AUGER® Boot Assembly

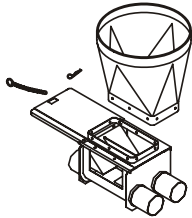

For clear upper boots add a “C” suffix to the Part No.. Example 8465C

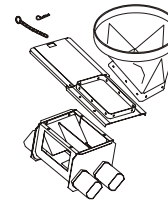

Part No.	Description	MODEL
<b>8465</b>	<b>Single 30 Degree Boot Assembly</b>	<b>55</b>
4347R	30 Degree Upper Boot Transition	
9313	Single 30 Degree Lower Boot Assembly	
<b>8466</b>	<b>Twin 30 Degree Boot Assembly</b>	<b>55</b>
4347R	30 Degree Upper Boot Transition	
9314	Twin 30 Degree Lower Boot Assembly	
<b>8467</b>	<b>Quad 30 Degree Boot Assembly</b>	<b>55</b>
4347R	30 Degree Upper Boot Transition	
9315	Quad 30 Degree Lower Boot Assembly	
<b>6539</b>	<b>Single 30 Degree Boot Assembly</b>	<b>75</b>
4347R	30 Degree Upper Boot Transition	
36442	Single Lower Boot Assembly	
<b>6540</b>	<b>Single Straight-Out Boot Assembly</b>	<b>75</b>
6093R	Straight-Out Upper Boot Transition	
36589	Single Straight-Out Lower Boot Assembly	
<b>6873</b>	<b>Twin 30 Degree Assembly</b>	<b>75</b>
4347R	30 Degree Upper Boot Transition	
36589	Single Straight-Out Lower Boot Assembly	
<b>36801</b>	<b>Twin Straight-Out Boot Assembly</b>	<b>75</b>
6093R	Straight-Out Upper Boot Transition	
36390	Twin Straight-Out Lower Boot Assembly	
<b>6541</b>	<b>Single Straight-Through Tandem System</b>	<b>75</b>
6093R	Straight-Out Upper Boot Transition (2 Required)	
36590	Single Straight-Through Lower Boot Package	
<b>35880</b>	<b>Twin Straight-Through Tandem System</b>	<b>75</b>
6093R	Straight-Out Upper Boot Transition (2 Required)	
36394	Twin Straight-Through Tandem Lower Boot Package	
<b>7881</b>	<b>Single 30 Degree Two Motor Tandem System</b>	<b>75</b>
3259-51	.50 Hp 60 Hz 348 RPM Power Unit	
4347R	30 Degree Upper Boot Transition	
6093R	Straight-Out Upper Boot Transition	
36589	Single Straight-Out Lower Boot Assembly	
9549	30 Degree Two Motor Tandem Lower Boot Assembly	
<b>6161</b>	<b>Single 30 Degree Boot Assembly</b>	<b>90</b>
4347R	30 Degree Upper Boot Transition	
9301	Single 30 Degree Lower Boot Assembly	
<b>6187</b>	<b>Single Straight-Out Boot Assembly</b>	<b>90</b>
6093R	Straight-Out Upper Boot Transition	
36435	Single Straight-Out Lower Boot Assembly	
<b>6874</b>	<b>Twin 30 Degree Boot Assembly</b>	<b>90</b>
4347R	30 Degree Upper Boot Transition	
36391	Twin 30 Degree Lower Boot Assembly	
<b>6535</b>	<b>Twin Straight-Through Boot Assembly</b>	<b>90</b>
6093R	Straight-Out Upper Boot Transition	
36398	Twin Straight-Out Lower Boot Assembly	
<b>6281</b>	<b>Single Straight-Through Tandem System</b>	<b>90</b>
6093R	Straight-Out Upper Boot Transition (2 Required)	
36434	Single Straight-Through Tandem Lower Boot Package	
<b>6538</b>	<b>Twin Straight-Through Tandem System</b>	<b>90</b>
6093R	Straight-Out Upper Boot Transition (2 Required)	
36388	Twin Straight-Through Tandem Lower BBoot Package	
<b>7882-2</b>	<b>Single 30 Degree Two Motor Tandem System</b>	<b>90</b>
3259-51	.50 Hp 60 Hz 348 RPM Power Unit	
4347R	30 Degree Upper Boot Transition	
6093R	Straight-Out Upper Boot Transition	
36435	Single Straight-Out Lower Boot Assembly	
9548	30 Degree Two Motor Tandem Lower Boot System	

<b>Part No.</b>	<b>Description</b>	<b>MODEL</b>
<b>40082</b> 6093R 40081	<b>Single Straight-Through Tandem System</b> Straight Out Upper Boot Transition (2 Required) Single Straight-Through Tandem Lower Boot Package	<b>HMC</b>
<b>7921</b> 4347R 38507	<b>Single 30 Degree Boot Assembly</b> 30 Degree Upper Boot Transition Single Lower Boot Assembly	<b>HMC</b>
<b>7920</b> 4347R 38506	<b>Twin 30 Degree Boot Assembly</b> 30 Degree Upper Boot Transition Twin 30 Degree Lower Boot Assembly	<b>HMC</b>
<b>36795</b> 6093R 36796	<b>Twin Straight-Through Tandem System</b> Straight Out Upper Boot Transition Twin Straight-Through Tandem Lower Boot Package	<b>HMC</b>
<b>25355</b> 38605 3259-51 4347R 6093R 38507	<b>Single 30 Degree Two Motor Tandem System</b> 30 Degree Two Motor Tandem Lower Boot Assembly .50 Hp 60 Hz 348 RPM Power Unit 30 Degree Upper Boot Transition Straight Out Upper Boot Transition Single Lower Boot Assembly	<b>HMC</b>
<b>34339</b> 4347R 34336	<b>Single 30 Degree Boot Assembly</b> 30 Degree Upper Boot Transition Single 30 Degree Lower Boot Assembly	<b>108</b>
<b>34340</b> 6093R 34341	<b>Single Straight-Out Boot Assembly</b> Straight-Out Upper Boot Transition Single Straight-Out Lower Boot Assembly	<b>108</b>
<b>34333</b> 6093R 34335 34341	<b>Single Straight-Through Tandem System</b> Straight-Out Upper Boot Transition (2 Required) Single Straight-Through Lower Boot Assembly Single Straight-Out Lower Boot Assembly	<b>108</b>
<b>34632</b> 6093R 6500-22 34631 34341	<b>Single Two Motor Tandem System (Add .5 HP Power Unit)</b> Straight-Out Upper Boot Transition (2 Required) Control Unit Single Straight-Through Lower Boot Assembly Single Straight-Out Lower Boot (2 Required)	<b>108</b>
<b>35625</b> 4347R 35613	<b>Twin 30 Degree Boot Assembly</b> 30 Degree Upper Boot Transition Twin 30 Degree Lower Boot Assembly	<b>108</b>
<b>35626</b> 6093R 35612	<b>Twin Straight-Out Boot Assembly</b> Straight-Out Upper Boot Transition Twin Straight-Out Lower Boot Assembly	<b>108</b>
<b>35616</b> 6093R 35612 35611	<b>Twin Straight-Through Tandem System</b> Straight-Out Upper Boot Transition (2 Required) Twin Straight-Out Lower Boot Assembly Twin Straight-Through Lower Boot Assembly	<b>108</b>

## Extension Hoppers

### Model 55, 75, 90, 108

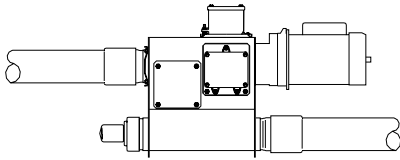

Part No	Description
7944	Model 75 Extension Hopper 1.5 Hp 1PH/3 PH
7869	Model 90 Extension Hopper 1.5 Hp 1 PH/3 PH
40170	Model 55 Extension Hopper 1.5 Hp 1 PH/3 PH
7849	Model HMC Extension Hopper 1.5 Hp 1 PH

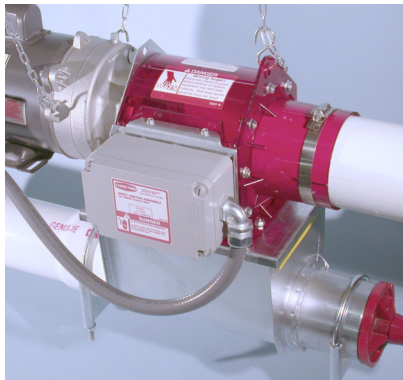

### Model 108 Extension Boot Kit

Part No	Description
47862-1	Model 108 Extension Boot Kit 230V 50/60 hz 1 Ph
47862-3	Model 108 Extension Boot Kit 3 Phase



### FLAG Extension Boot

FLAG Extension boot must be ordered by components.

Part No	Description
35727	Single Boot
46800-1	Control Unit
45970	Adapter Plate
34779	Boot Switch

### 30 Degree Two Motor Tandem Boots

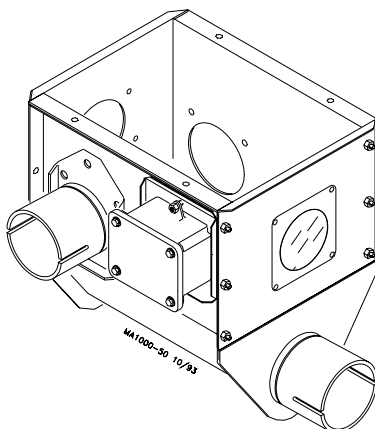

Part No	Description
9549	Model 75 Two Motor Tandem Boot
9548	Model 90 Two Motor Tandem Boot
38605	Model HMC Two Motor Tandem Boot

# Auger, Bearing Assemblies, Driver Assemblies

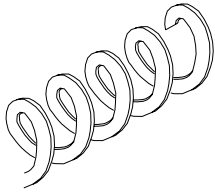

## Augers

Part No.	Description
7961	Model 55 Auger (1.52 O.D.)
4744	Model 75 Auger (2.38 O.D.)
6942	Model 90 Auger (2.71 O.D.)
30108	Model 108 Auger (3.56 O.D.)

## Non-Restricted Anchor Bearing Assembly

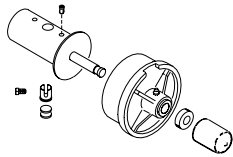

Part No.	Description
37347	Model 75
35345	Model 90
37241	Model HMC
35766	Model 108

## Restricted Anchor Bearing Assembly

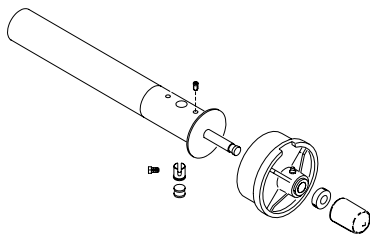

Part No.	Description
37346	Model 75
35343	Model 90
35344	Model HMC
35767	Model 108

## Cap Assembly



Part No.	Description
35440	Model 75
34830	Model 90
34830	Model HMC
30314	Model 108

## Bearing Assembly

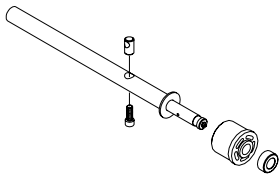

Part No.	Description
39405	Model 55 Boot Bearing
39408	FLAG Anchor Bearing

## Bearing Safety Cap

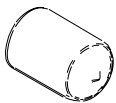

Part No.	Description
29702	Bearing Safety Cap
35410	Bearing Cap Kit (Replaces metal cap Model HMC and 90)
37351	Bearing Cap Kit (Replaces metal cap Model 75)

## Driver Assembly

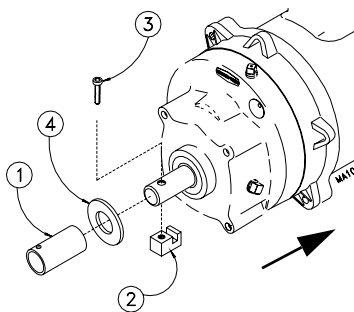

Item	Description	Model 55	FLAG
		Part No	Part No
1	Drive Tube	2920	30932
2	Drive Block	4642	4642
3	Screw	5083-8	5083-4
4	Washer	1484	1484

Part No.	Description
6862	Model 75 & HMC
6861	Model 90
30313	Model 108

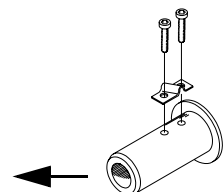

# FLEX-AUGER® Tubes and Elbows (Including connectors and clamp kits)

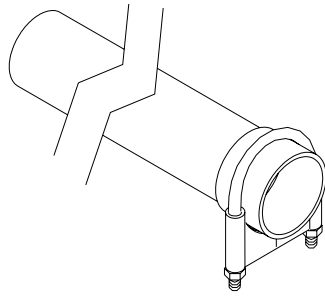

### Steel Tubing

- 2088 Model 75 10' Tube with belled end
- 5091 Model 90 10' Tube with belled end
- 34411 Model 108 10' Tube with belled end
- 5089 Model 90 32" Tube with belled end

### PVC Tubing

- 7955 Model 55/MULTIFLO 10' Tube
- 6516 Model 75 10' Tube
- 6293 Model 90 & HMC 10' Tube
- 34547 Model 108 10' Tube

### PVC Elbows

- 34855 Model 55 Elbow 45 degree
- 7357 Model 90 & HMC Elbow 45 degree
- 7285 Model 75 Elbow 45 degree
- 34546 Model 108 Elbow 45 degree

### Hardened Steel Elbows

- 14324 Model 75 Hardened Steel Elbow 45 degree
- 6472 Model 90 Hardened Steel Elbow 45 degree
- 34406 Model 108 Hardened Steel Elbow 45 degree

### Steel Tube Connectors

- 6512 Model 75 Tube Connector only (Steel Connector/PVC Pipe)
- 2106 Model 75 Tube Connector only
- 5088 Model 90 Tube Connector only
- 30277 Model 108 Tube Connector only
- 6525 Model 75 Tube Connector w/clamps (Steel Connector/PVC Pipe)
- 2103 Model 75 Tube Connector w/clamps
- 6595 Model 90 Tube Connector w/clamps
- 34419 Model 108 Tube Connector w/clamps

### Coupler PVC

- 8029 Model 55 MULTIFLO & FLAG Coupler (PVC)
- 7084 Model 75 Coupler (PVC)
- 7085 Model 90 & HMC Coupler (PVC)
- 34557 Model 108 Coupler (PVC)

### Tube Inserts

- 6524 Model 75 Tube Insert (Steel)
- 34337 Model 108 Tube Insert (PVC)

### Tube Clamps

- 29520 Model 55 Tube Clamp (Bearing Clamp)
- 29515 Model 55 and MULTIFLO Tube Clamp
- 35726 Model 55 Tube Clamp (FLAG Boot Outlet)
- 6515 Model 75 Tube Clamp (PVC)
- 4141 Model 75 Tube Clamp (Steel)
- 6721 Model 90 and HMC Tube Clamp (PVC or Steel)
- 14373 Model 108 Tube Clamp 5" (PVC)
- 34338 Model 108 Tube Clamp 4.25" (Steel)

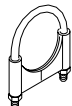
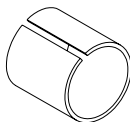
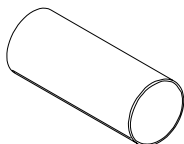
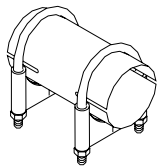
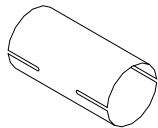
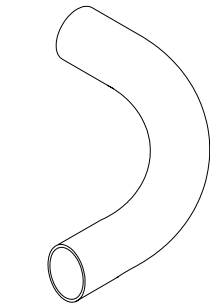

1922-12 4/2007



## Outlet Drops and Accessories

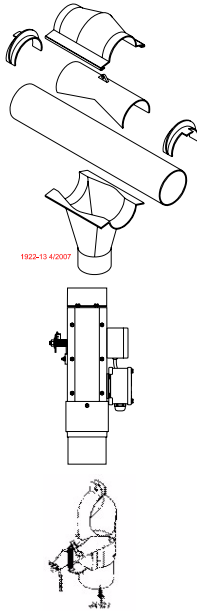

### Outlet Drop

Part No	Description	Usage
43455C	Model 55 Outlet with clamp ring	Model 55, MULTIFLO
43455R	Model 55 Outlet with retainer	
43475C	Model 75 Outlet with clamp ring	Model 75
43475R	Model 75 Outlet with retainer	
43490C	Model 90 Outlet with clamp ring	Model 90
43490R	Model 90 Outlet with retainer	
29174	Model 75 Electric outlet drop	Model 75
28417	Model 90 Electric outlet drop	Model 90
5163	Model 75 Single outlet with butterfly shut-off (Steel)	Model 75

### Drop Tubes

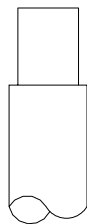

Part No	Description	Usage
1932	Plastic drop tube (3" x 12')	Model 55, 75, MULTIFLO
6381	Plastic drop tube (3.75" x 12')	Model 90, HMC
9900	Plastic drop tube (5" x 12')	Model 108 control units
14366-1932	Telescoping drop tube (3.568" x 6')	Model 55, 75, MULTIFLO
14366-6381	Telescoping drop tube (4.125" x 6')	Model 90 & HMC
14366-9900	Telescoping drop tube (5.25" x 6')	Model 108
14367	Drop tube support kit	Model 55, 75, 90, 108

### Flex Tube



Part No	Description	Usage
13265-1	SS Flex metal tube (3" x 25')	Model 55, 75, MULTIFLO
13265-2	SS Flex metal tube (3 3/8" x 25')	Model 90, HMC
13265-3	SS Flex metal tube (5" x 25')	Model 108
7497	Galv. Flex metal tube (3" x 50')	Model 55, 75, MULTIFLO
6383	Galv. Flex metal tube (3 1/2" x 50')	Model 90, HMC
1931	Galv. Flex metal tube (3" x 18")	Model 55, 75, MULTIFLO
6382	Galv. Flex metal tube (3 1/2" x 18")	Model 90, HMC

### Suspension Kits

Part No	Description	Usage
5043	Suspension kit	Model 75, 90, HMC, 108
6372	Suspension kit	Model 55, MULTIFLO

### Accessories

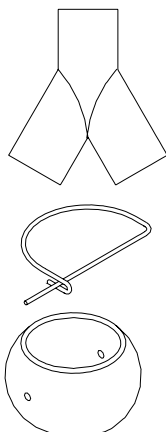

Part No	Description	Usage
39187	WYE Outlet 3 x 3 x 3	Model 55, 75, MULTIFLO
6303	PVC cement (1/2 pint)	All PVC tubing
6303-4	PVC cement (1 quart)	
41657	Lock pin	Model 55, 90
41440	Lock pin	Model 90, 108
41717	Flex joint ring	Model 55, 75
42201	Flex joint ring	Model 90, HMC

## Control Units

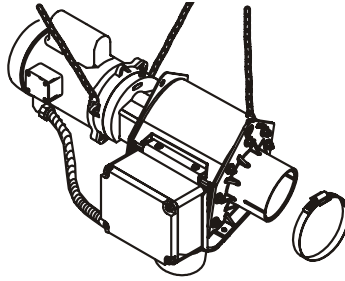

### DIRECT DRIVE

46800-1	MODEL 55 CONTROL UNIT	220V-50/60HZ-1 PH
46800-2	MODEL 75 CONTROL UNIT	220V-50/60HZ-1 PH
46800-3	MODEL HMC CONTROL UNIT	220V-50/60HZ-1 PH
46800-4	MODEL 90 CONTROL UNIT	220V-50/60HZ-1 PH
46800-5	MODEL 108 CONTROL UNIT	230V-50/60HZ-1 PH

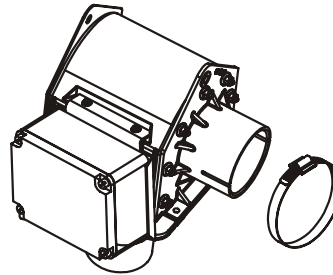

### THREE PHASE

46800-6	MODEL 55 CONTROL UNIT	3 PHASE
46800-7	MODEL 75 CONTROL UNIT	3 PHASE
46800-8	MODEL HMC CONTROL UNIT	3 PHASE
46800-9	MODEL 90 CONTROL UNIT	3 PHASE
46800-10	MODEL 108 CONTROL UNIT	3 PHASE

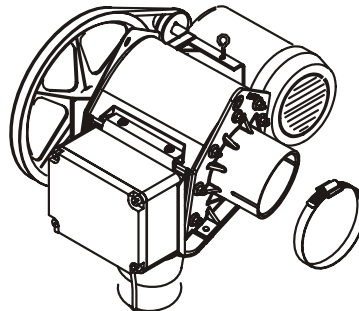

### BELT DRIVE UNITS

46800-11	MODEL 55 BELT DRIVE CONTROL UNIT	220V-50/60HZ-1 PH
46800-12	MODEL 75 BELT DRIVE CONTROL UNIT	220V-50/60HZ-1 PH
46800-13	MODEL HMC BELT DRIVE CONTROL UNIT	220V-50/60HZ-1 PH
46800-14	MODEL 90 BELT DRIVE CONTROL UNIT	220V-50/60HZ-1 PH
46800-15	MODEL 108 BELT DRIVE CONTROL UNIT	220V-50/60HZ-1PH

## Bin Fill Cap Kits

### Intermediate fill cap kits

The intermediate bin fill cap kit allows direct filling of an intermediate hopper bin. The fill cap lid is removable to allow feed truck filling if desired. The intermediate caps have shut-off slides to allow the intermediate bin to be bypassed when full.

**The intermediate fill caps do not have level switches supplied and are manually operated shut-off slides.**

### Terminal bin fill cap kits

The terminal bin fill cap kits allow direct filling of a terminal hopper bin with a FLEX-AUGER when desired. The fill cap lid is removable to allow feed truck filling if desired.

**No level switches are supplied with these fill cap kits.**

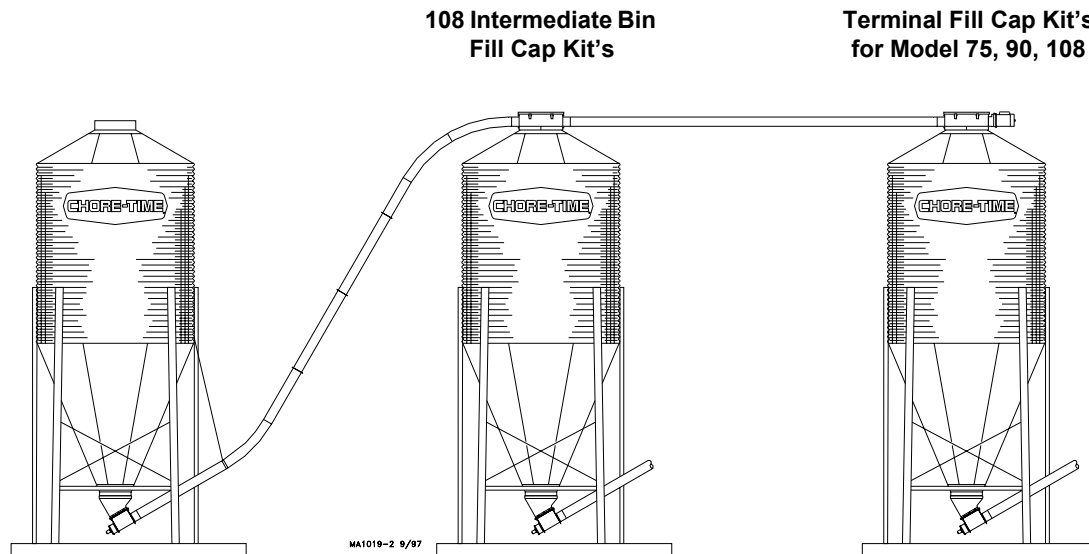

### INTERMEDIATE BIN FILL CAP KITS

### TERMINAL BIN FILL CAP KITS

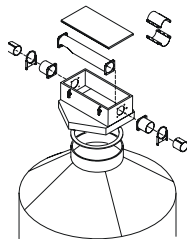

SINGLE INTERMEDIATE FILL CAP KITS	
PART NO	DESCRIPTION
40527	MODEL 108 FILL CAP KIT

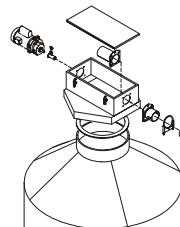

SINGLE FILL CAP KITS	
PART NO	DESCRIPTION
6563	MODEL 75 FILL CAP KIT
25806	MODEL 90 FILL CAP KIT
34635	MODEL 108 FILL CAP KIT

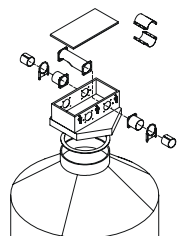

TWIN INTERMEDIATE FILL CAP KITS	
PART NO	DESCRIPTION
40526	MODEL 108 FILL CAP KIT

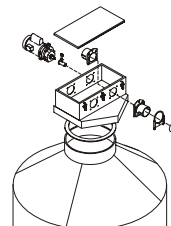

TWIN FILL CAP KITS	
PART NO	DESCRIPTION
27133	MODEL 90 FILL CAP KIT
35008	MODEL 108 FILL CAP KIT

### Model 108 Bin-to-Bin fill cap kits

The Model 108 Bin-to-Bin fill cap kit is designed to accommodate filling or bypassing a hopper bin in a multiple bin application. The last bin in a series will use a terminal bin fill cap kit. The Bin-to-Bin fill cap kits replace the existing lid or lids on top of an intermediate bin in a multiple bin fill system. The Bin-to-Bin fill cap kit will allow in line, right had or left hand turns in the fill system layout. The Model 108 Bin-to-Bin fill cap use's an electronic control to determine which bins to bypass and which bins to fill.

No level switches are supplied with these fill cap kits.

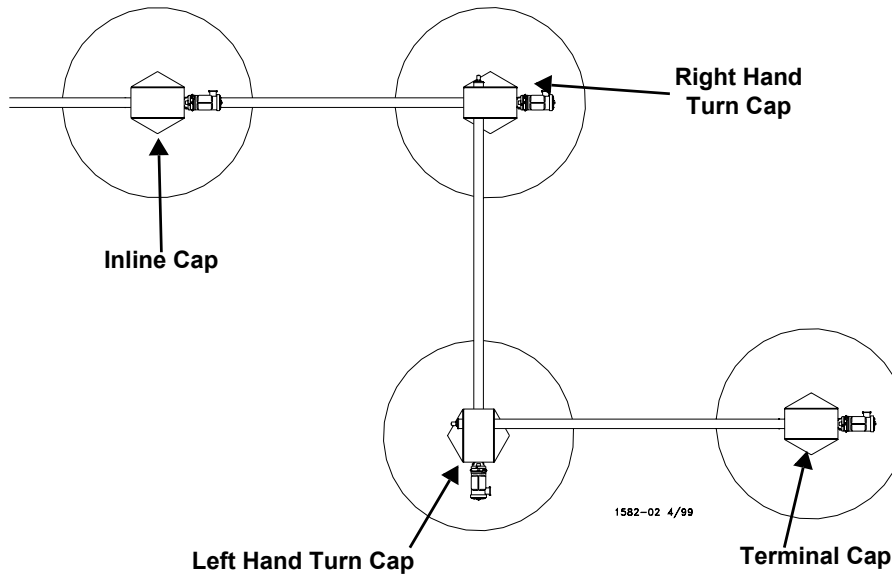
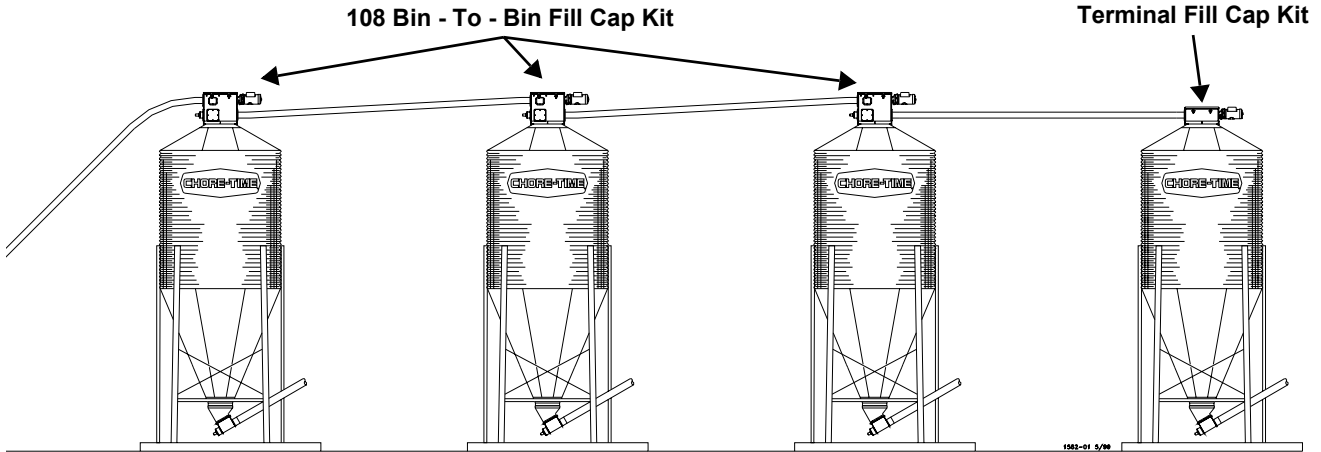

## Power Units

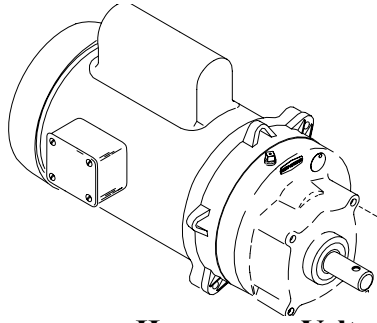

Part No	HP	RPM	Phase	Hz	Voltage	Usage
3259-34	1/3	348	Single	60	230	55, FLAG™
3259-67	1/2	129	Single	60	230	MULTIFLO® Fill
3259-50	1/2	216	Single	60	230	75, 90, HMC, 108
3259-39	1/2	348	Single	60	230	55, FLAG™
3259-51	1/2	348	Single	60	230	75, 90, HMC
3259-77	1/2	425	Single	60	230	75, 90, HMC
3259-134	1/2	348	Three	60	220/380	55
3259-136	3/4	216	Single	60	230	75, 90, HMC, 108
3259-78	3/4	425	Single	60	230	75, 90, HMC
3259-122	3/4	584	Single	60	230	ULTRAFLO® Breeder Fill
3259-119	3/4	348	Three	60	230/460	75, 90, HMC, 108
3259-120	3/4	425	Three	60	230/460	75, 90, HMC
3259-52	3/4	348	Single	60	230	75, 90, HMC, 108
3259-49	1	348	Single	60	230	75, 90, HMC, 108
3259-79	1	425	Single	60	230	75, 90, HMC, 108
3259-123	1	584	Single	60	230	ULTRAFLO® Breeder Fill
3259-135	1	348	Three	60	220/380	75, 90, HMC, 108
3259-117	1	348	Three	60	230/460	75, 90, HMC, 108
3259-118	1	425	Three	60	230/460	108
3259-137	1	584	Three	60	220/380	ULTRAFLO® Breeder Fill
3259-152	1	584	Three	60	220/380	ULTRAPAN® Breeder Fill
3259-66	1 1/2	348	Single	60	230	108
3259-80	1 1/2	425	Single	60	230	108
3259-124	1 1/2	584	Single	60	230	ULTRAFLO® Breeder Fill
3259-139	1 1/2	348	Three	60	230/460	108
3259-139	1 1/2	348	Three	60	230/460	108
3259-140	1 1/2	425	Three	60	230/460	108
3259-121	2	425	Single	60	230	108
3259-90	1 1/2	348	Single	50	220	108
3259-109	1/2	180	Single	50	220	MULTIFLO®
3259-98	1/2	348	Single	50	220	55, FLAG™
3259-102	1/2	180	Three	50	220/380	MULTIFLO® Fill
3259-100	1/2	348	Three	50	220/380	55, FLAG™
3259-88	3/4	348	Single	50	220	75, 90, HMC, 108
3259-104	3/4	348	Three	50	220/380	75, 90, HMC, 108
3259-89	1	348	Single	50	220	75, 90, HMC, 108
3259-148	1	580	Single	50	220	ULTRAPAN® Breeder Fill
3259-105	1	348	Three	50	220/380	75, 90, HMC, 108
3259-150	1	580	Three	50	220-240/340-400	ULTRAPAN® Breeder Fill
3259-149	1 1/2	580	Single	50	220	ULTRAPAN® Breeder Fill
3259-106	1 1/2	348	Three	50	220/380	108
3259-151	1 1/2	580	Three	50	220-240/2380-400	ULTRAPAN® Breeder Fill

## Switches and Timers

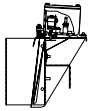

### Hopper Level Switches

- |       |                                   |                         |
|-------|-----------------------------------|-------------------------|
| 14550 | Hopper Level Control              | 230V - 50/60 hz 1 Phase |
| 2912  | Hopper Level Control              | 110V - 50/60 hz 1 Phase |
| 27761 | Hopper Level Control              | 230V - 50/60 hz 3 Phase |
| 42613 | Hopper Level Switch W/SENSOR PLUS |                         |
| 46910 | Panel Switch W/SENSOR PLUS        |                         |

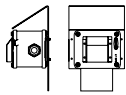

### Proximity Drop Tube Switches

- |       |   |                      |
|-------|---|----------------------|
| 49260 | Universal Drop Tube Switch W/SENSOR PLUS                  | 230V - 50/60 hz 1 PH |
| 49264 | Universal Drop Tube Switch W/SENSOR PLUS and Safety Timer | 230V - 50/60 hz 1 PH |
| 46316 | Drop Tube Switch W/SENSOR PLUS                            | 230V - 50/60 hz 1 PH |
| 46663 | Drop Tube Switch W/SENSOR PLUS & Safety Timer             | 230V - 50/60 hz 1 PH |

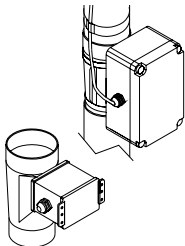

### Control Level Switches

- |       |  |                         |
|-------|--|-------------------------|
| 47847 | C. U. Extension Switch W/Delay               | 230V - 50/60 hz 1 Phase |
| 47846 | C. U. Extension Switch W/O Delay             | 230V - 50/60 hz 1 Phase |
| 47831 | C. U. Level Switch (1 sec - 10 min) W/Relay  | 230V - 50/60 hz 1 Phase |
| 47832 | C. U. Level Switch (1sec - 10 min) W/O Relay | 230V - 50/60 hz 1 Phase |
| 47830 | C. U. Level Switch (1 sec - 60 min) W/Relay  | 230V - 50/60 hz 1 Phase |

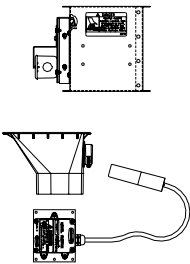

### Boot Switches

- |       |   |
|-------|---|
| 6143  | Boot Switch & Plate Assembly (Single)                     |
| 6411  | Boot Switch & Plate Assembly (Twin)                       |
| 34780 | Boot Switch (Prox Switch Single Boot) W/Cannon Ball Guard |
| 34779 | Boot Switch (Prox Switch Twin Boot) W/O Cannon Ball Guard |
| 37553 | Upper Boot Switch (Prox Switch)                           |

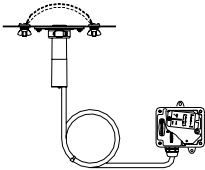

### Sleeve Switch MULTIFLO®

- |       |   |
|-------|---|
| 40508 | MULTIFLO Proximity Sleeve Switch (W/Override Timer) |
|-------|---|

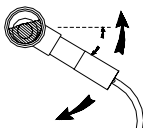

### Contactors

- |         |   |                             |
|---------|---|-----------------------------|
| 24392-1 | Watertight Contactor Box (1 contactor)  | 208/240V - 50/60 hz 1 Phase |
| 24392-2 | Watertight Contactor Box (2 contactors) | 208/240V - 50/60 hz 1 Phase |
| 24392-3 | Watertight Contactor Box (3 contactors) | 208/240V - 50/60 hz 1 Phase |

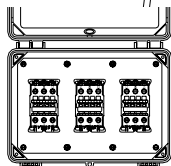

### Time Clock

- |       |  |                         |
|-------|--|-------------------------|
| 26230 | Time Clock and Contactor (Plastic Box) | 220V - 50/60 hz 1 Phase |
| 34574 | 4 Channel Time Clock (AGRI-TIME®)      | 230V - 50/60 hz 1 Phase |
| 50388 | 8 Timer Control (AGRI-TIME®)           |                         |

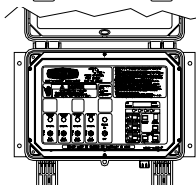

### Auger Timer

- |       |                    |
|-------|--------------------|
| 46662 | Auger Safety Timer |
|-------|--------------------|

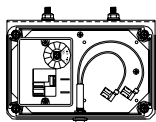

### Delay Relays

- |       |  |
|-------|--|
| 28702 | Delay Relay (for 30370 Drop Feeder Controls) |
| 30953 | Delay Relay (for FLAG Fill System Motor)     |

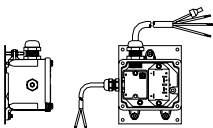

**Drop Feeder Control**

28999 Drop Feeder Control (Use with 28990-9, 28990-18) 220V 60 hz 1 Ph

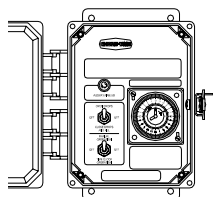

**Interval Timer**

- 47805 Run Timer (One Timer)
- 47805-2 Run Timer (Two Timers)
- 47805-3 Run Timer (Three Timers)
- 47805-4 Tun Timer (Four Timers)
- 47810 Single Timer in 4 x 6" Box

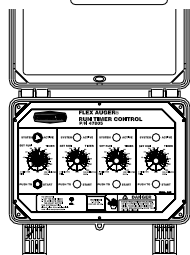

**Misc.**

- 1977 Time Clock (24 hour/115 Volt) Metal Box
- 3710 Time Clock (24 hour/230 Volt) Metal Box

**Single Contactors**

- 42549 Single Contactor 230 VAC Coil 50/60 Hz
- 44853 Single Contactor 110 VAC Coil 50/60 Hz

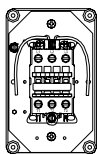

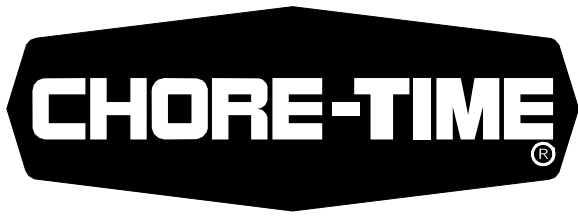

**FLEX-AUGER<sup>®</sup>**  
**SYSTEMS**

**MULTIFLO<sup>®</sup> System**



# MULTIFLO® System

## Information

### General Information

The MULTIFLO® feed delivery system will convey dry meal, crumbles, or pellet feeds with particle size up to 3/16" [5 mm] in diameter. The MULTIFLO system is not recommended for high-moisture feeds. An electronic control switch is utilized to control the feed recirculation and allow the system to purge itself at each operation.

**NOTE: MAXIMUM OF 2 HOURS OPERATING TIME PER DAY.**

### The Fill System

Each MULTIFLO system loop is charged with a FLEX-AUGER® fill system. Appropriate Flex-Augers for this purpose would be a Model 55 with standard power unit or Model 75 and HMC FLEX-AUGER with 129 rpm power units. The high speed MULTIFLO is filled with a Model 75 FLEX-AUGER with a standard power unit. These Flex-Augers are ordered from the Flex-Auger price list.

### The MULTIFLO® Boot

The MULTIFLO boots are supplied with adapter plates to make a connection between FLEX-AUGER and control units or an outlet and the boot. Terminal boots are utilized under control units and intermediate boots are utilized under outlet assemblies.

### Tube and Elbows

Determine the amount of 90 or 180 degree elbows and tube required for the installation. **NOTE: MAXIMUM OF FOUR 90° OR TWO 180° ELBOWS PER SYSTEM.**

### Power Unit(s)

Order the appropriate number of power units based on the **effective length of 400' [122 m] per power unit**. The power unit requirement is determined by the **effective length** of the system (not actual length). **Effective Length**= Total length of the straight line system + 30' [9 m] for each 90 degree elbow or + 60' [18 m] for each 180° degree elbow.

MAXIMUM 1200' [366 M] EFFECTIVE LENGTH SYSTEMS - Example: Three power units with 1080' [329 m] straight line length and four 90° elbows.

### Control Switch

The proximity sleeve switch is used on the MULTIFLO circulating feed system as the control to allow operation and shut-off without unnecessary recirculation. The proximity sleeve switch is designed to allow the circuit to dispense feed until it is filled. The proximity sleeve switch controls the MULTIFLO circuit motor(s). The fill system motor incorporates an override timer to allow the system to purge itself at the next operation time. One proximity sleeve switch is required for each loop or circuit.

### Component Parts

Order the service section, bridge clamp, suspension kits, and PVC cement based on system length from component parts listing.

### Accessories

Order the appropriate outlet and control accessories according to the system's intended usage.

## Planning the MULTIFLO® System

Planning for the MULTIFLO® installation should be coordinated with planning for the FLEX-AUGER® feed delivery system installation so the advantages of each system can be used effectively. See the FLEX-AUGER operator's manual for information regarding the FLEX-AUGER feed delivery system.

Chains, “S” Hooks, and screw hooks are provided to suspend the system at least every 5' (1.5 m). The elbows should be supported in at least 2 places.

**Important: Keep the system as straight and level as possible.**

### MULTIFLO® Boot Placement

The MULTIFLO Side Draw Boot placement is determined by where the FLEX-AUGER feed delivery system is terminated. Installation of the FLEX-AUGER feed delivery system should be planned with this in mind. The MULTIFLO Side Draw Boot is directional.

**Important: It is not recommended to place the MULTIFLO Boot directly adjoining an elbow. Try to locate the boot a few feet prior to/or after an elbow in the system.**

### Determine Where to Install Power Units

Note placement of the power units See “Examples of MULTIFLO® System Layout” on page 35..

See “MULTIFLO® Effective Length Calculation” on page 38. to determine the Effective Length of the system.

**The “Effective Length” between Power Units must not exceed 400' (122 m) regardless of the number or position of elbows**

Power Units should be placed evenly around the system keeping:

- Single Power Units opposite the boot
- Boot approximately centered between two power units in multiple power unit systems (See “Examples of MULTIFLO® System Layout” on page 35. **Examples 2-4**)
- The “Effective Length” per power unit should be kept as equal (even) as possible.

If possible, install the Power Units in a straight section of tube and not adjacent to an elbow. See Example 1 on page 35.

### Outlet Drop Size and Placement

A 1-1/2” (38 mm) hole is required at each outlet drop or drop feeder location. The last drop feeder before the control unit should not be more than 3' (1 m) from the control unit.

DO NOT install outlet drops on elbows, feed is required to cushion the auger here. The maximum angle of the outlet drop is 30 degrees.

## Examples of MULTIFLO® System Layout

**Example 1** shows a typical MULTIFLO® installation. Feed is brought into the building with a FLEX-AUGER® Delivery System to the MULTIFLO boot. Notice how the motor is spaced opposite the boot around the MULTIFLO system.

**Example 2** shows a FLEX-AUGER system supplying four different MULTIFLO loops. This system could be used to feed rooms in a sow farrowing operation. Notice the use of 180 degree elbows to accommodate the narrow aisles in a farrowing room. Also notice the Intermediate Boots are located under the Outlet Assemblies in the first three rooms.

**Example 3** shows a FLEX-AUGER Feed Delivery System with a twin boot supplying two similar sized MULTIFLO loops. As with all FLEX-AUGER to MULTIFLO systems adapter plates were installed on the FLEX-AUGER control units to attach the control units to the MULTIFLO boots. The Adapter Plates are supplied with the MULTIFLO boots.

**Example 4** shows a FLEX-AUGER Feed Delivery System filling multiple MULTIFLO loops. This configuration requires outlet assemblies on the fill system to fill loops 1 and 2 and the fill system control unit would be over loop 3.

**Example 1**

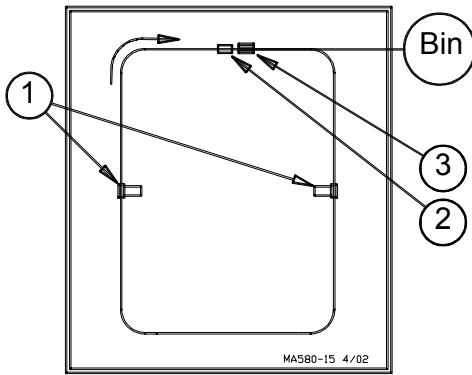

Item	Description
1	Power Unit
2	Level Switch
3	MULTIFLO Boot

**Example 2**

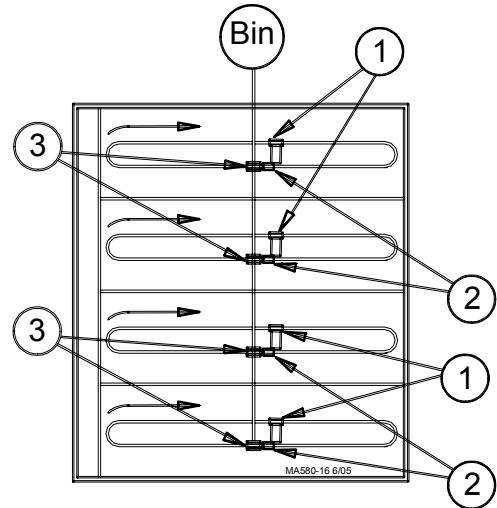

**Example 3**

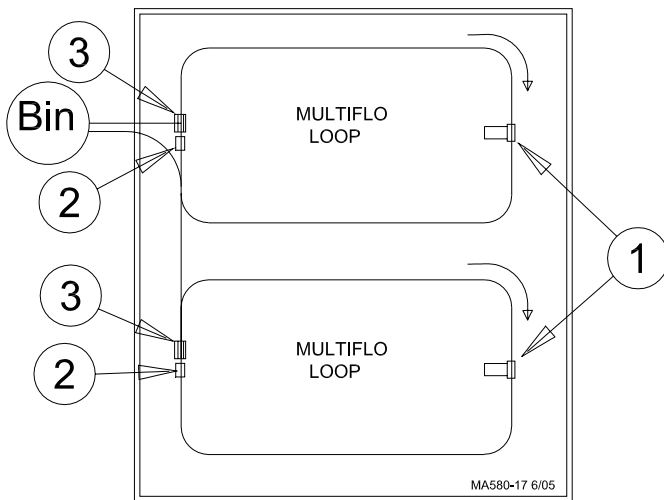

**Example 4**

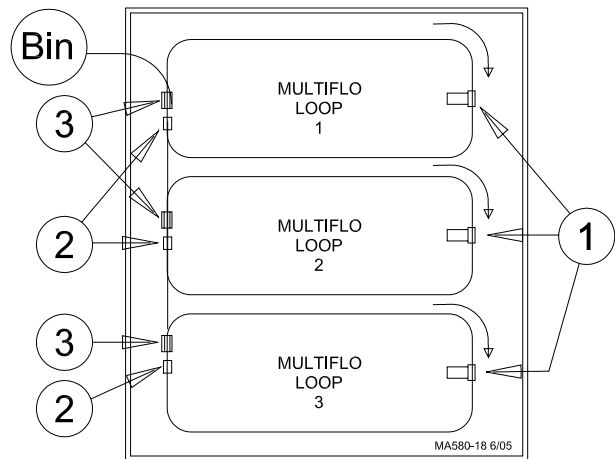

Diagrams below show possible power unit locations in relation to the FLEX-AUGER fill system.

**Example 5 One Motor System**

**Example 6 Two Motor System**

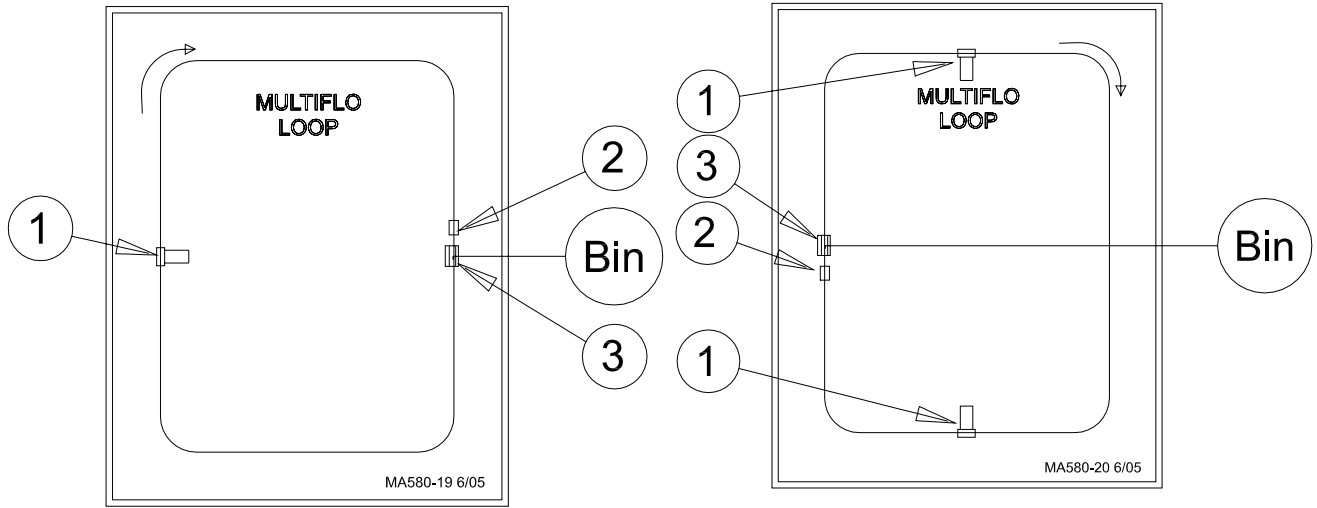

**Example 7 Three Motor System**

Item	Description
1	Power Unit
2	Level Switch
3	MULTIFLO Boot

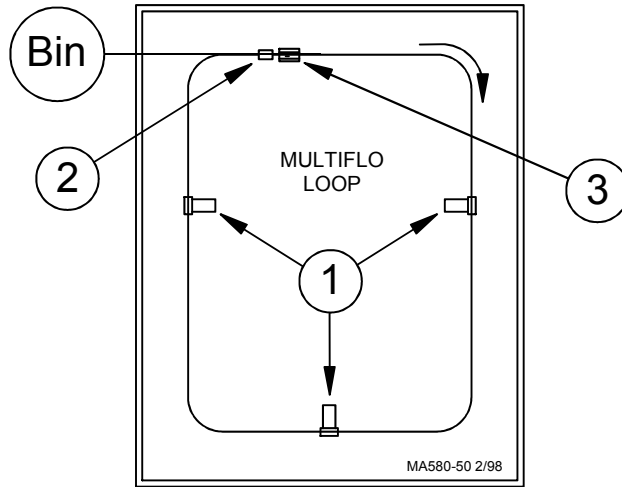

Remember, these are examples only. The MULTIFLO System’s versatility will provide almost unlimited combinations of delivery system designs. **Follow these guidelines for placement of components.**

## MULTIFLO® SPECIFICATIONS

The MULTIFLO® Feed Delivery System is a closed “loop” system which pulls the auger through the tube. The system is used primarily in nurseries, gestation, and dairy houses. **It is recommended for systems with running times of less than 2 hours per day and no high moisture corn.**

Read all instructions carefully and familiarize yourself with the components before beginning to install the MULTIFLO® system. Determine approximate layout of the system where each component will be placed, how much space it will require, how it will be suspended, and so forth. be careful to plan the system so it does not interfere with ventilation, watering systems, or other equipment in the building. “Examples of MULTIFLO® System Layout” on page 35 shows some possible MULTIFLO® “layouts”. These are to be used as examples only.

### Auger Information

7961MF Auger is specifically designed for use in MULTIFLO® Systems. It differs from standard 7961 Auger used with Model 55 Feeding Systems, the 7961MF Auger contains no factory brazes. MULTIFLO® Auger should be connected using an Auger Connector when it is necessary to join sections of the 7961MF Auger. However, the welding or brazing technique is acceptable. Remember, brazing MULTIFLO® auger is considerable different than for other Chore-Time auger systems (see MULTIFLO manual).

### Auger Specifications

**Auger Tube:** 55 mm PVC Tube

**Elbows:** 90 degree, 2" (51 mm) I.D. two piece nylon elbow w/24" (610 mm) center line radius. **The maximum number of 90 degree elbows allowed for each MULTIFLO® loop is 4.**

180 degree, 2.12" (54 mm) O.D. x 2" I.D. Hardened Steel Elbow w/39" (990 mm) center to center turn. **The maximum number of 180 degree elbows allowed for each MULTIFLO® loop is 2.**

**Auger:** 7961MF for systems 400' (122 m) or shorter, auger should be one piece. Maximum length auger for shipment is 400' (122 m). It is important to specify length of the system when ordering auger. Auger for longer systems will be sent in most desirable section lengths. Example: for a 450' (137 m) MULTIFLO® System, it would be better to use two 225' (69 m) sections of auger than one 400' (122 m) section and one 50' (15 m) section. Specify system length and Chore-Time will supply the best available combination of auger. Handle auger carefully. Store flat if it is to be stored for a period of time prior to installation.

**Auger Drive:** Helical Gear.

**Power Unit:** Standard 1/2 HP, 62 RPM Direct Drive, 230 V, 60 Hz; 220 V, 50 Hz, Single Phase; 380 V, 50 Hz, 3 Phase

Hi-Speed 3/4 HP, 95 RPM Direct Drive, 230 V, 60 Hz, Single Phase

**Power Unit Capacity:** 400' (122 m) Effective Length. Effective Length is based on feed with 40 lb/cu.ft (64 kg/cu. meter) density.

**System Capacity:** 1200' (366 m) Effective Length (with three Power Units-maximum)

Delivery Capacity:

Standard: 15 lb/min (6.8 kg/min) with Model 55 FLEX AUGER® Fill System

Standard: 18 lb/min (8.1 kg/min) with Model 75 or HMC FLEX AUGER® Fill System @ 129 RPM

Hi-Speed: 50 lb/min (22.6 kg/min) with Model 75 or HMC FLEX AUGER® Fill System @ 348 RPM

**Feed Types:** Ground feeds, crumbles, and pellets up to/including 3/16" dia. x 1/2" long (4.7 x 12.7 mm), not to exceed 18% moisture. **The MULTIFLO® system is not recommended for high moisture feed.**

### MULTIFLO® Effective Length Calculation

The Effective Length if a MULTIFLO System is calculated an shown. Before beginning to install the system, determine the Effective Length of the system.

**Important: You must know the Effective Length before placing the power units, service section area, and other system components.**

**Effective Length = Total Feet (meters) of Straight Lengths  
PLUS  
Number of 90° Elbows x 30' (9.1 m)  
or  
Number of 180° Elbows x 60' 18.2 m)**

**Example with 90° Elbow:**

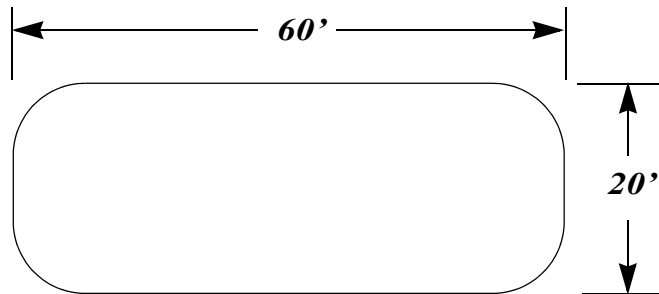

60' x 2 = 120', 20' x 2 = 40': given straight line length of 160'  
 4 (90 degree elbows) x 30' = 120': given elbow length of 120'  
 Straight line length (160') + elbow length (120') = Effective Length (280')

**Example with 180° Elbow:**

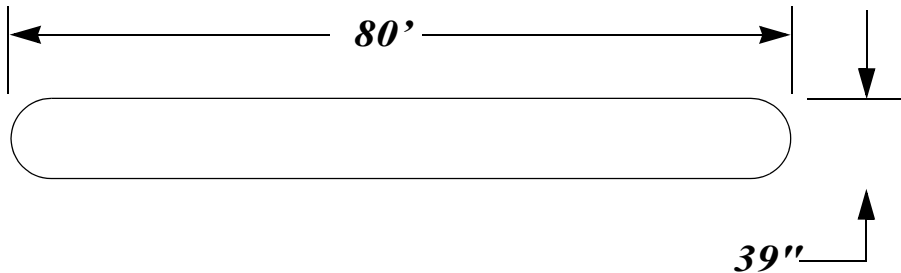

80' x 2 = 160': given straight line length of 160'  
 2 (180 degree elbows) x 60' = 120': given elbow length of 120'  
 Straight line length (160') + elbow length (120') = Effective Length (280')

# MULTIFLO® Components

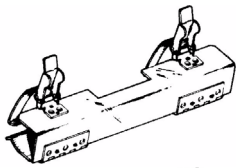

**8264 MULTIFLO Auger Brazing Fixture**

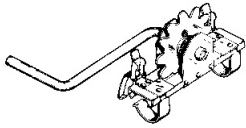

**8697 MULTIFLO Hand Crank Assembly**

**9349 MULTIFLO Installation Kit (Includes: 8697 qty 3, 8264 qty 1)**

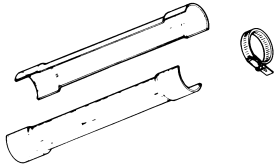

**8710 MULTIFLO Service Section (1 per circuit)**

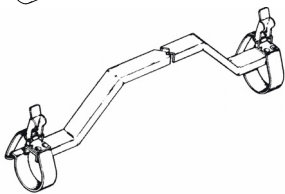

**8227 MULTIFLO Bridge Clamp**



**MULTIFLO Auger Connector (2 per bag)**

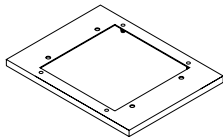

**45970 Adapter Plate Assembly**

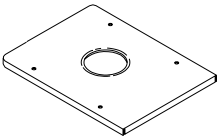

**29872 Transfer Cover Plate**

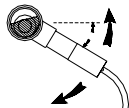

**40508 MULTIFLO Proximity Sleeve Switch W/Override Timer**

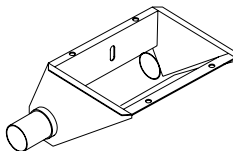

**14411 MULTIFLO Terminal Boot**

**47581 MULTIFLO Intermediate Boot**

**46325 MULTIFLO Hi Speed Terminal Boot**

**47582 MULTIFLO Hi Speed Intermediate Boot**



**8719 Closure Kit (Includes: 8718 Closure qty 1, 8643 Clamp qty 2)**

## Drive Units

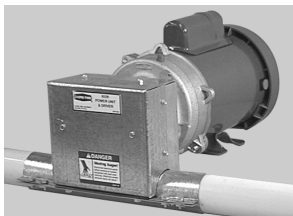

**41013 1/2 Hp - 62 RPM Power Unit & Driver Assembly 230V-60hz - 1 Ph**

**41014 .4 Hp - 62 RPM Power Unit & Driver Assembly 220V-50hz - 1 Ph**

**28830 1/2 Hp - 62 RPM Power Unit & Driver Assembly 220/380V-50hz - 3 Ph**

**46311 3/4 Hp - 95 RPM Power Unit & Driver Assembly 230V-60hz - 1 Ph**

### MULTIFLO® Elbows

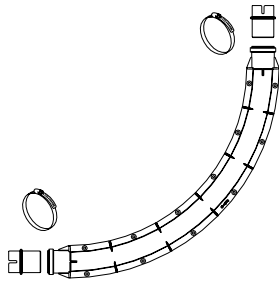

- 47950 MULTIFLO Elbow Kit
- 46779 Elbow Half
- 46778 MULTIFLO Adapter
- 47947 MULTIFLO Elbow Hardware Kit

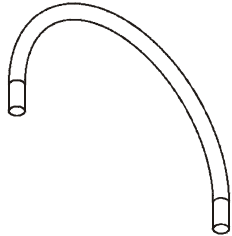

- 46720 MULTIFLO 180 Degree Elbow Kit
- 46719 MULTIFLO Elbow 180 Degree



- 40507 MULTIFLO 90 Degree Elbow (Includes: (1) 39204 Elbow, (2) 39200 Elbow Couplers, (2) 8643 Band Clamps)



- 39204 Hardened Steel 90 Degree Elbow

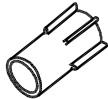

- 39200 Elbow Connector (used with 39204)



- 8643 Band Clamp (used with 39204 and 39200)

### MULTIFLO® PVC Tubing and Auger

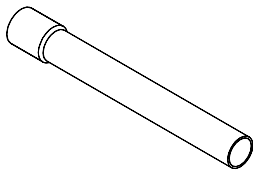

- 7955 Model 55, MULTIFLO Tube 10' [3 m]

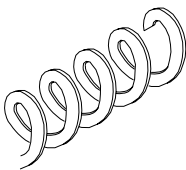

- 7961MF MULTIFLO Auger



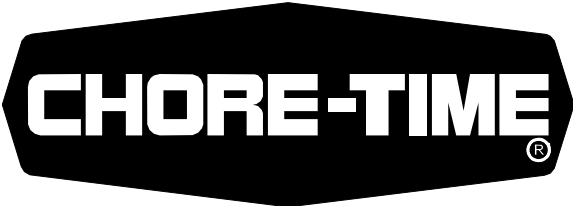

**FLEX-AUGER<sup>®</sup>  
SYSTEMS**

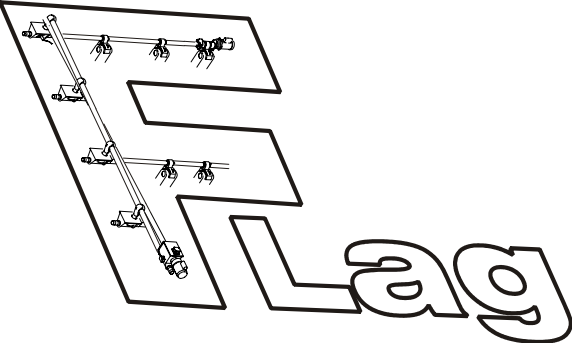

**FLEX**  
A graphic of a coiled spring, rendered in a simple line-art style, arching over the word AUGER.  
**AUGER<sup>®</sup>**

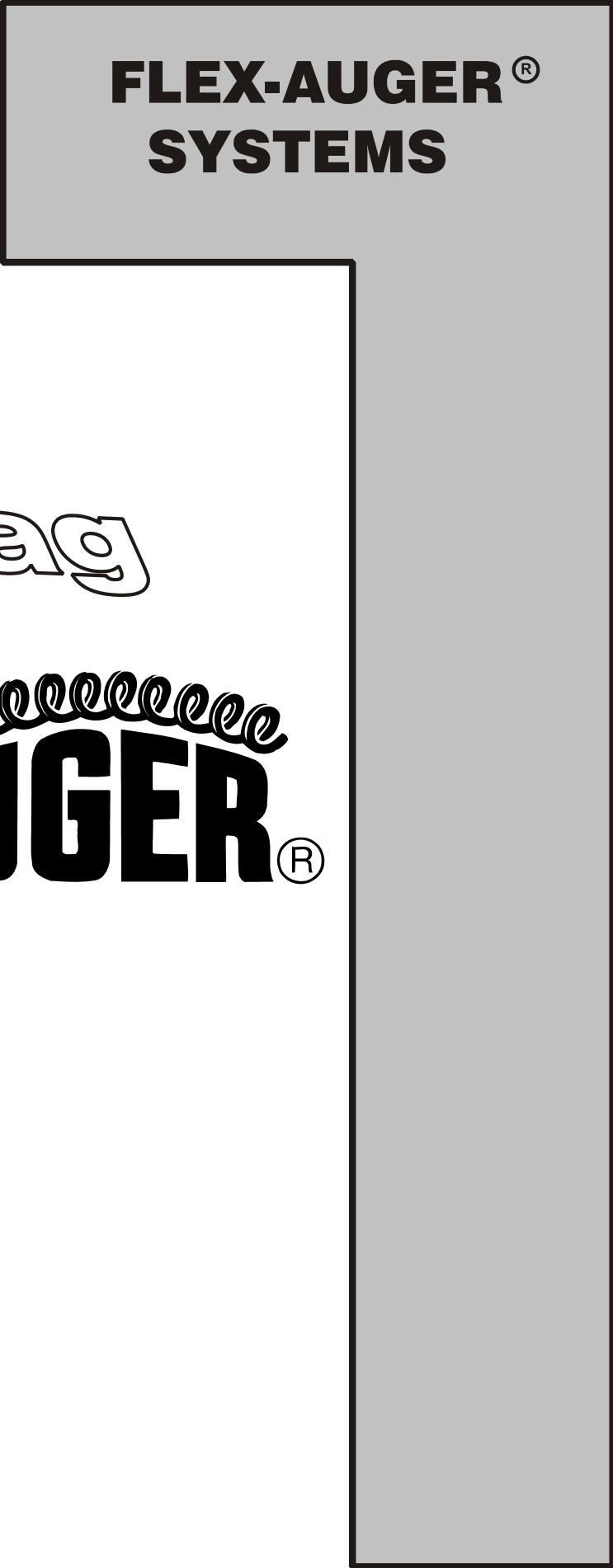

# FLAG™ System

## System information

### General information

The FLAG™ System is designed for applications that require several distribution lines from one source location. The FLAG system consists of multiple FLAG feeder lines that are supplied by a Model 75 or Model 90 FLEX-AUGER® fill system. The FLAG system application is recommended for low capacity delivery requirements such as Drop Feeding.

### Specifications

The FLAG™ System is designed to convey dry meal, crumbles, or pellet feeds with particle size up to 1/8” [4 mm] in diameter and is not recommended for high-moisture feeds. The feed delivery rate of an individual line is 20 lbs/min [9 kg/min]. Maximum line length is 400’ [122 m].

### The Fill System

The FLAG™ System is supplied with feed from a Model 75 or Model 90 FLEX-AUGER® Fill System. Depending on the application, there are options for the type of fill system layout that can be used including dead end, return, circulating, and return-to-bin. The appropriate FLEX-AUGER size for this purpose depends on the number of FLAG lines to be supplied. See “Fill System Power Unit Selection Guide” on page 11 for determining the proper size to provide sufficient feed, without over-charging the system.

Part No. 30953 Delay/relay kit is recommended for use with the FLAG Fill System to avoid potential short cycling.

### Transfer boot and switch

The transfer boots for the FLAG™ System are available in a single and twin configuration. When using a dead end fill system, Part No. 45970 adaptor plate will be needed to connect the control unit to the last transfer boot. It is advisable to use the Part No. 34779 proximity boot switch for all FLAG lines that may operate more than 10 minutes without feed. The boot switch will prevent excessive empty auger operation time.

### Auger

The FLAG™ System can be used in straight line applications only. The Part No. 25058F auger can be ordered in lengths from 50’ [15 m] to 400’ [122 m].

### Controls

The selection of available controls to operate the FLAG™ System will be based on the type of application. For a manual dumped Drop Feeding system, use the Part No. 47805-0 series interval timer(s) or the Part No. 46662 run/safety timer. For an automatic Drop Feeding system, use the Part No. 28999 control panel.

## FLAG™ line power unit selection guide

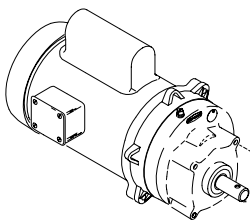

<b>230 Volt 60 Hz 1 Phase</b>	
Up to 200’ [61 m] 3259-34	200’ [61 m] to 400’ [122 m] 3259-39
<b>220 Volt 50 Hz 1 Phase</b>	
Up to 400’ [122 m] 3259-98	
<b>220/380 Volt 50 Hz 3 Phase</b>	
Up to 400’ [122 m] 3259-100	

# FLAG™ System Layouts

## Standard FLAG™ System Layout

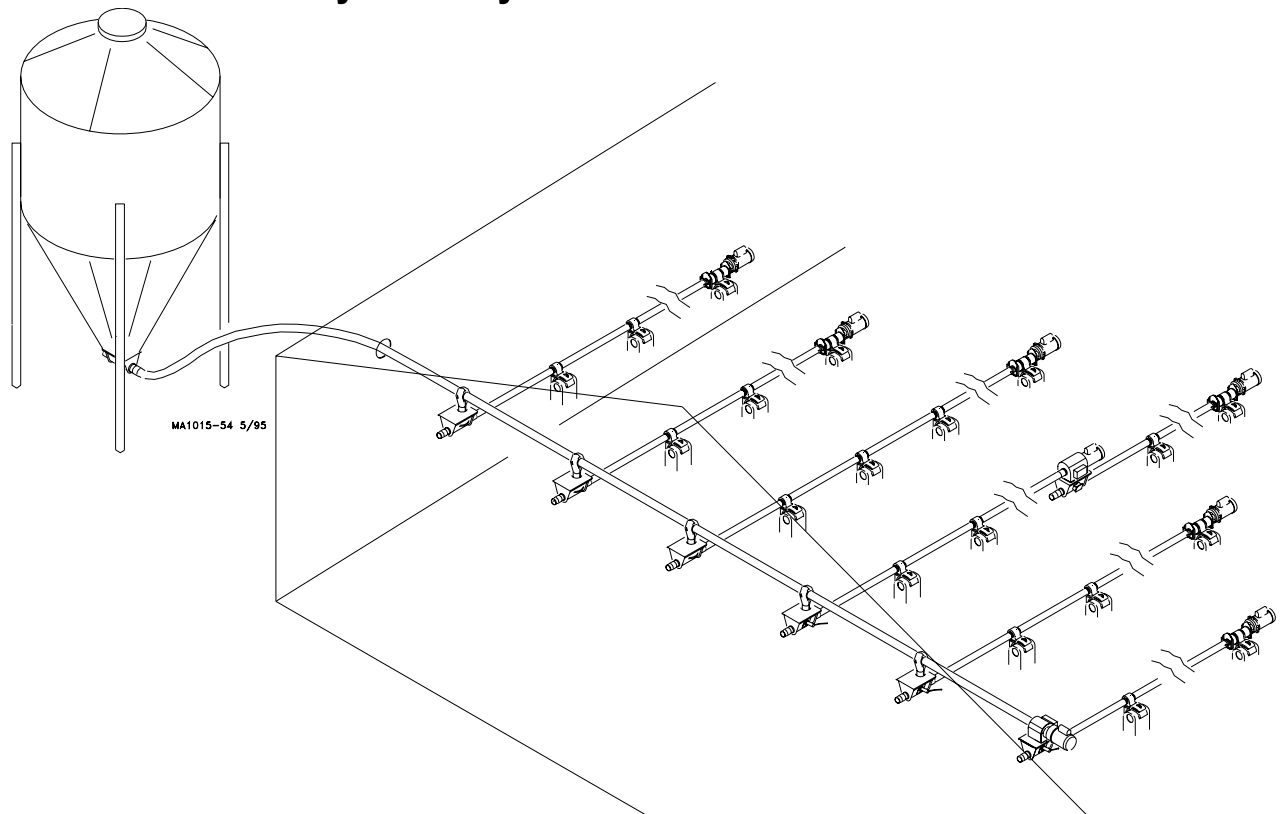

## Alternate Layout FLAG™ Return Fill System Layout

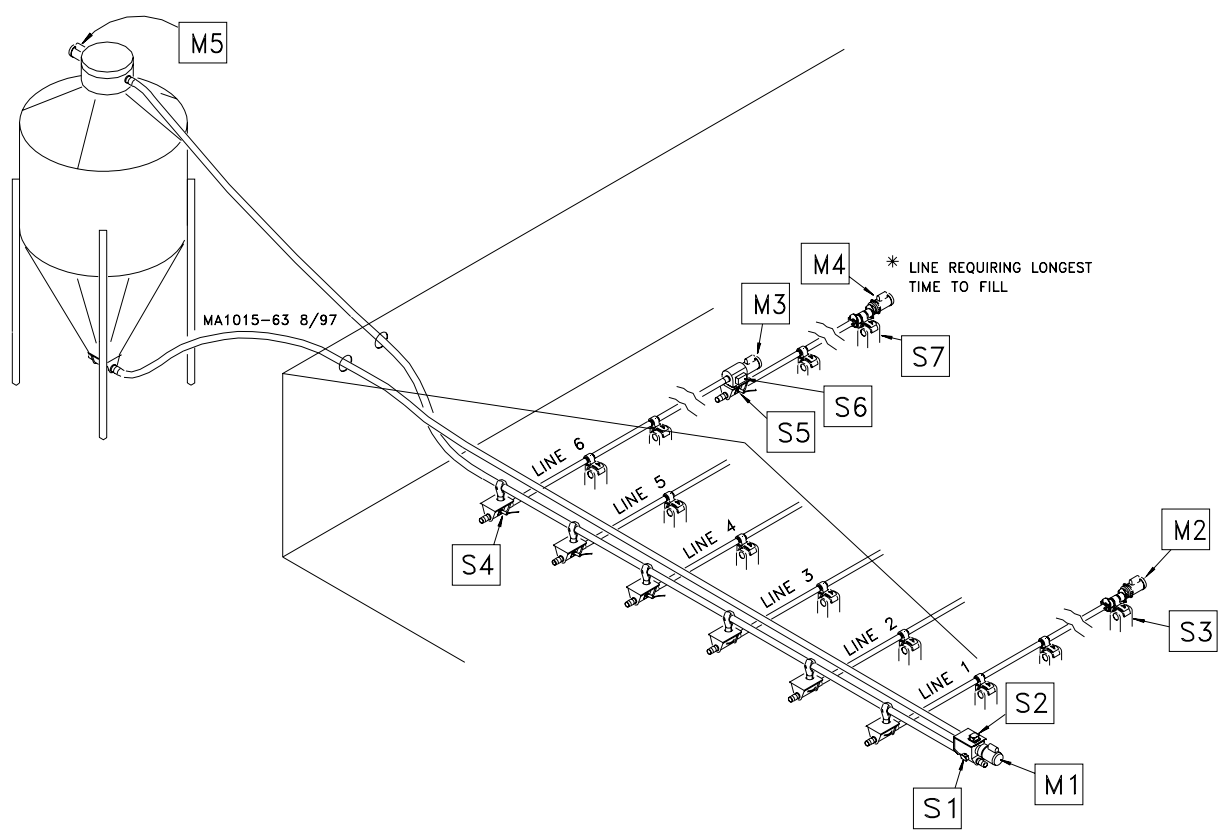

### Alternate Layout Twin Boot FLAG™ System Layout

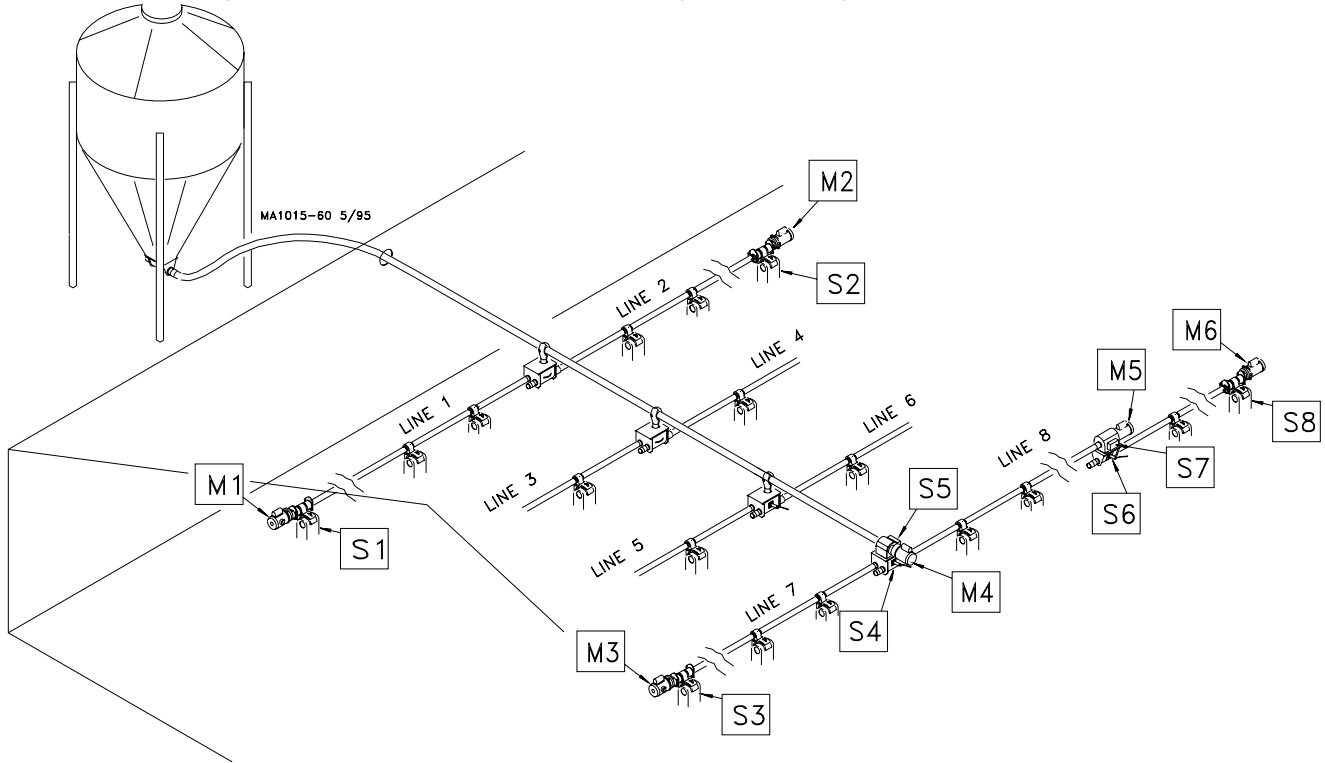

### Alternate Layout FLAG™ Circulating Fill System Layout

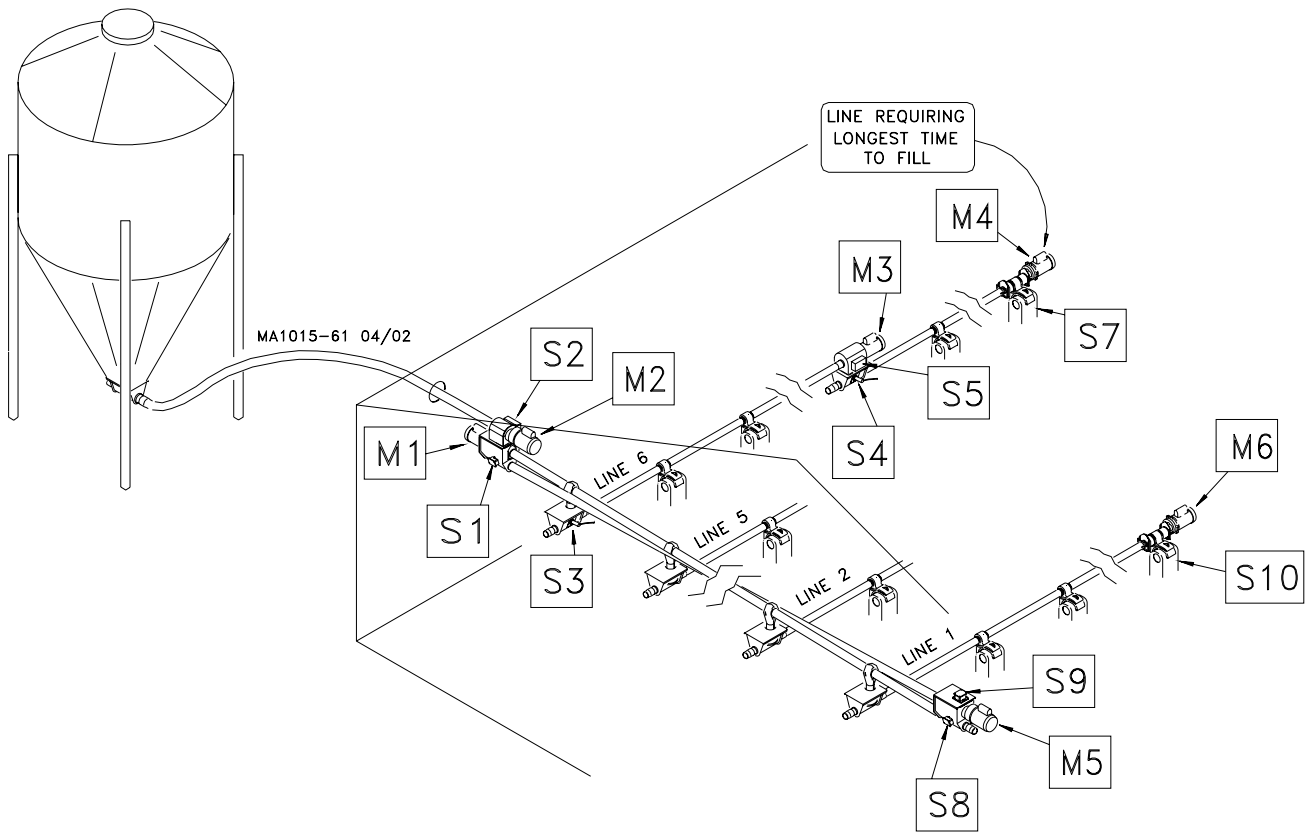

# FLAG™ System Boot Options

## Terminal Boot

The terminal boot is used on the last FLAG™ Line to fill on a dead end fill system. This line acts as the control line to shut off the fill system.

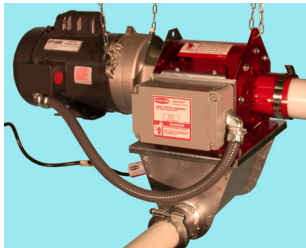

The delay relay kit will minimize short cycling of the fill system motor.

- 35727 Single Transfer Boot Assembly**
- 45970 Adapter Plate**
- 34779 Boot Switch (if required)**
- 30953 Delay Relay Kit**

## Transfer Boot

The transfer boot is the standard FLAG line boot. To be filled through outlet assemblies on the fill system.

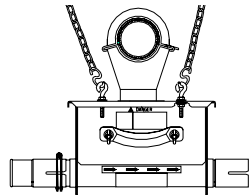

- 35727 Single Transfer Boot Assembly**

## Transfer Boot with Proximity Switch

The proximity boot switch allows the FLAG line only to run when there is feed present. The boot switch should be used on any FLAG lines that might run empty longer than 10 minutes.

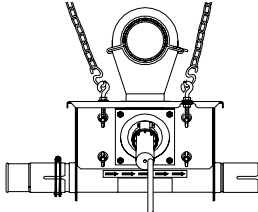

- 35727 Single Transfer Boot Assembly**
- 34779 Boot Switch**

## Center Twin Transfer Boot

- 35942 Twin Transfer Boot**
- 34779 Boot Switch (if required) 2 required**

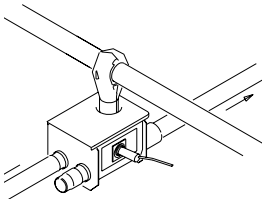

## Center Twin Terminal Boot

- 35942 Twin Transfer Boot**
- 45970 Adapter Plate**
- 34779 Boot Switch (if required) 2 required**
- 30953 Delay Relay Kit**

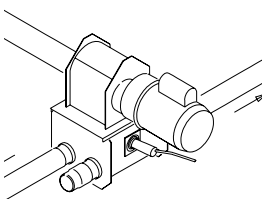

## Extension Boot

The extension boot option allows extending the FLAG line/lines longer than 400' [121.9 m].

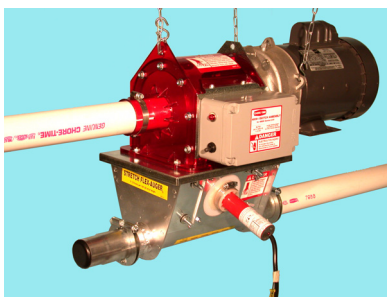

- 35727 Single Transfer Boot**
- 45970 Adapter Plate**
- 34779 Boot Switch**
- 46800-1 Control Unit**



**FLEX-AUGER<sup>®</sup>  
SYSTEMS**

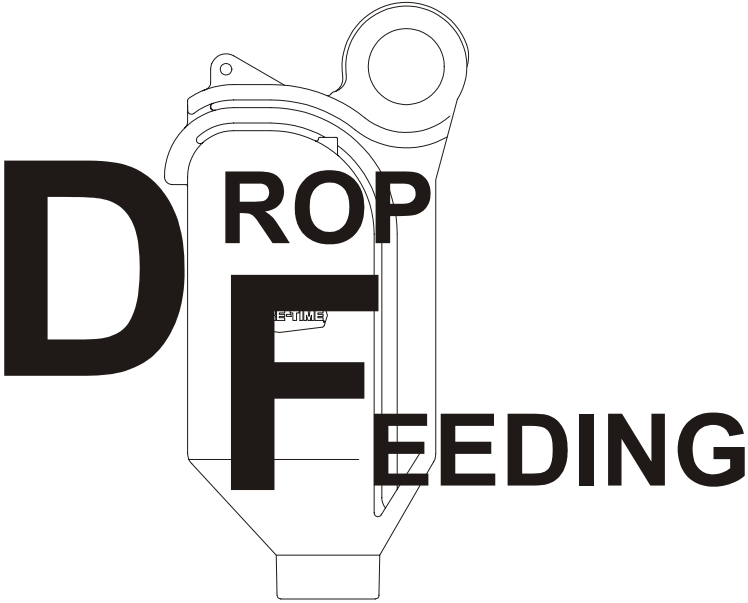

# Drop Feeding System

## System Information

### The Feed Delivery System

Determine the required FLEX-AUGER® System for the application. The Drop Feeding System can be used with the FLEX-AUGER Models 55, 75, and HMC, plus the MULTIFLO® and FLAG™ Systems. The FLEX-Auger control unit and hopper switch are not required for a Drop Feeding application.

### Drop Feeders and Drop Feeder Control Units

Order the required number of drop feeders from the system. Note: Each drop feeder control unit also functions as a drop feeder. One Drop Feeder control unit is required from each FLEX-AUGER® or FLAG™ line. Drop Feeder control units are available with mechanical or electronic switches.

When the Part No. series 30370-0 mechanical control units are used with a manual trip system, a Part No. 28702 delay relay will be needed for each line unless a run timer or interval timer(s) are utilized. The Part No. series 34800-0 electronic Drop Feeder controls have built-in delays.

### Feeding Control Options

The Drop Feeding system may be dumped manually or automatically depending on the application. For manual dumped systems; the Part No. 6306 manual trip lever (for up to 40 feeders) or the Part No. 29428 drum winch (for up to 200 feeders) can be used.

For automatic dumped systems use the Part No. 28990-9 linear actuator (for up to 120 feeders) or the 28990-18 linear actuator (for up to 240 feeders). The linear actuator(s) are used with the Part No. 28999 Drop Feeder control panel. One Part No. 28999 Drop Feeder control panel will operate up to four actuators. A contactor is required for the Drop Feeder control to operate the fill systems. An additional contactor is required if more than one actuator is used.

### Drop Tubes

Order, as needed, the appropriate drop tube and drop tube clamps (see listing).

### Cable

For manually activated systems, order enough cable for the length of each feeding system line. For automatically activated systems, order enough 1/8" [3.2 mm] cable for each line plus order 3/16" [4.8 mm] master cable to be used from the linear actuator to the feeder line cables.

**Note: HMC Drop Feeding systems are not to be used for feeds above 27% moisture.**

# Drop Feeding System Layouts

## Linear Actuator Installations

Note: The linear actuator is optional and must be ordered separately. Information included in this manual is for planning and reference purposes only. The linear actuator instruction manual includes comprehensive planning, installation, parts listing, switch adjustment information, and wiring diagrams. The linear actuator installation manual is shipped with the linear actuator.

The Part No. 28990-9 linear actuator has the capability of operating up to 120 Drop Feeders.

The Part No. 28990-18 linear actuator has the capability of operating up to 240 Drop Feeders.

When installing a linear actuator, allow room at the end of the system for the weight kit to move freely.

The linear actuator uses a 3/16" [4.8 mm] stainless steel master cable and a 1/8" [3.2 mm] stainless steel cable for the balance of the system. The maximum length of 1/8" [3.2 mm] stainless steel cable allowed per line is 200' [61 m]. If installing a 28990-18 linear actuator, allow enough room to install the double-back cable hook-up, as specified in the linear actuator installation manual. One anti-cable wrap ball should be installed on each horizontal length of 1/8" [3.2 mm] that runs between two pulleys.

Note: On long cable runs, it may be necessary to install two anti-cable wrap balls to prevent cable from twisting.

### Drop Feeding system layout

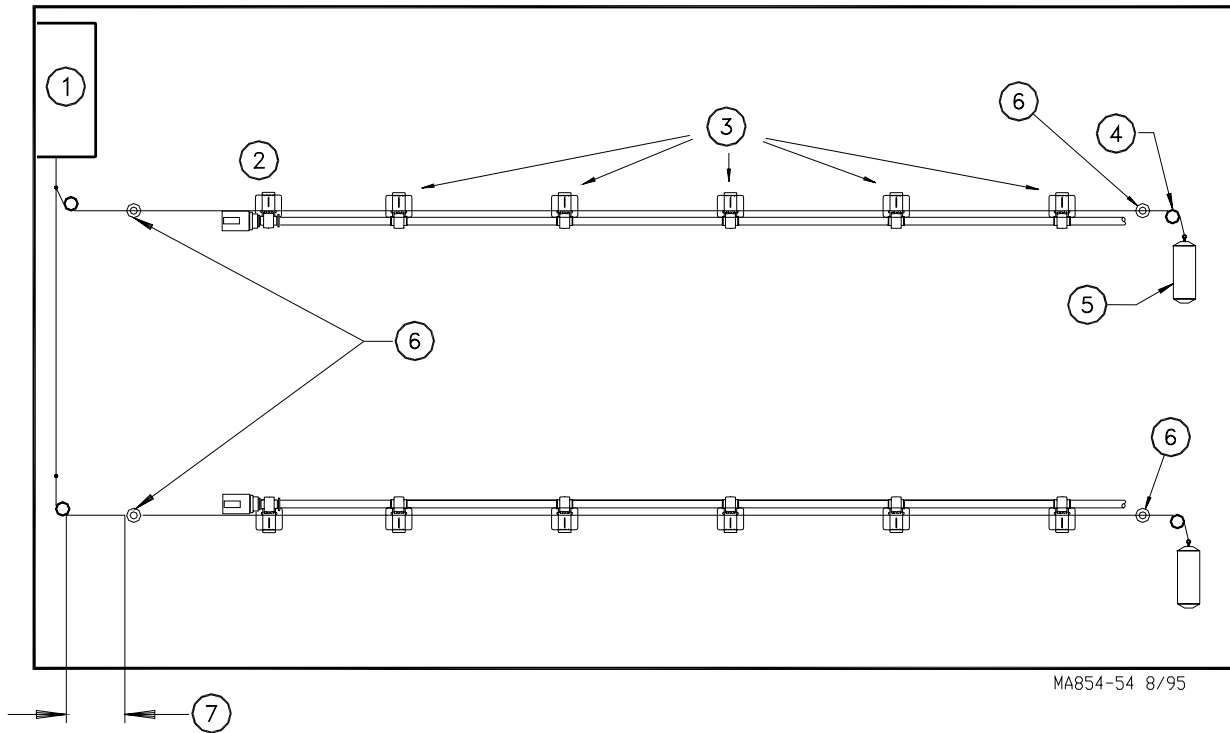

Item	Description
1	Linear Actuator
2	Drop Feeder Control Unit
3	Drop Feeder
4	Pulley
5	Weight
6	Anti-Cable Wrap Ball
7	This distance must be greater than cable travel
8	3/16" Master Cable
9	1/8" Cable



### Drop Feeding System Layout Using Multiple Linear Actuators

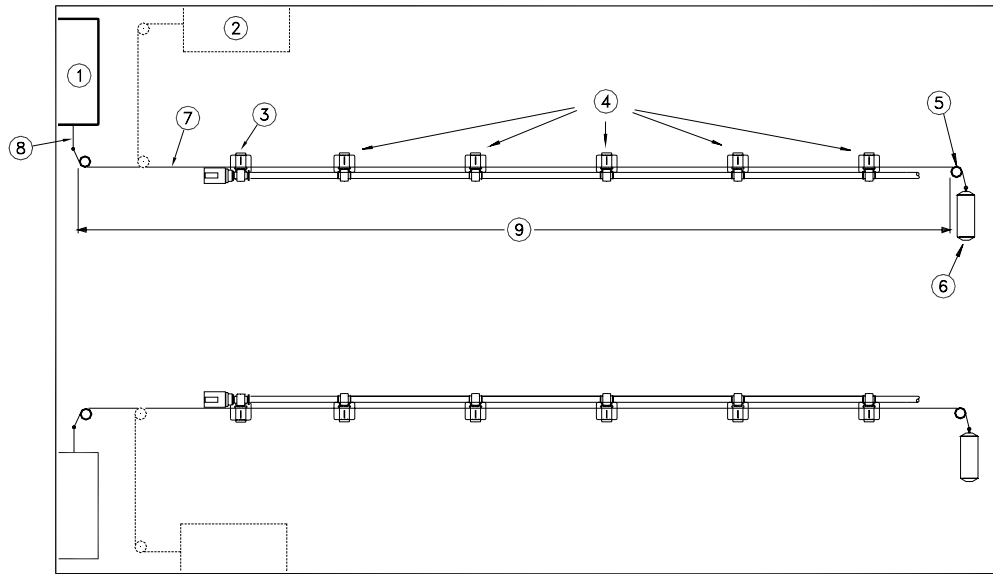

MA854-5 8/95

Item	Description
1	Linear Actuator
2	Linear Actuator (optional location)
3	Drop Feeder Control Unit
4	Drop Feeder
5	Pulley
6	Weight
7	1/8" [3.1 mm] Stainless Steel Cable
8	3/16" [4.7 mm] Stainless Steel Cable
9	200' [61 m] Maximum

### Drop Feeding System Layout Using Multiple Linear Actuators

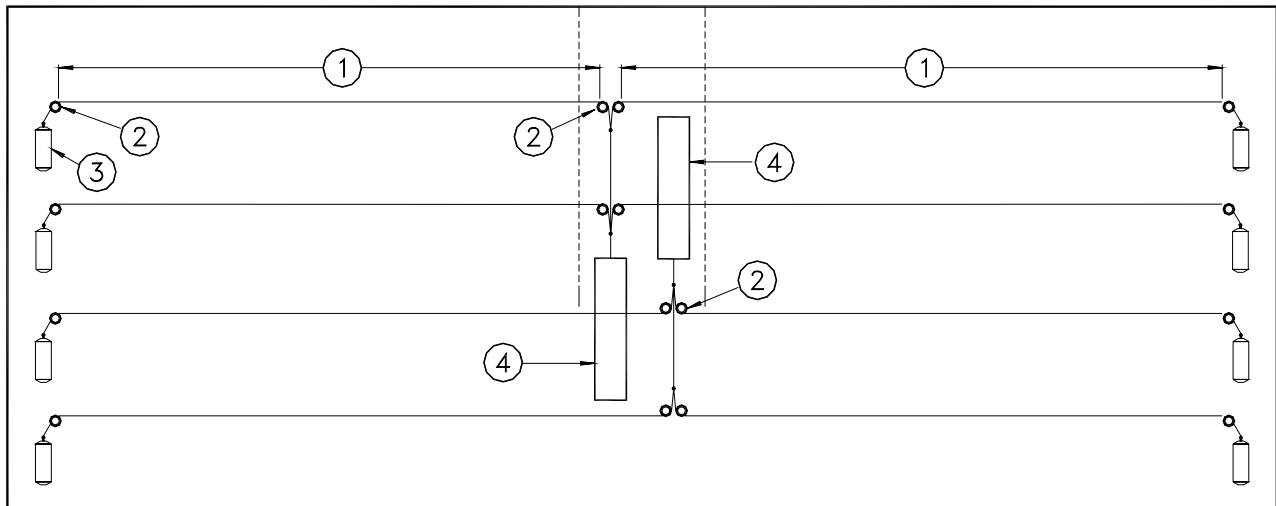

MA854-6 8/95

Item	Description
1	200' [61 m] Maximum
2	Pulley
3	Weight
4	Linear Actuator
5	3/16" [4.7 mm] Master Cable
6	1/8" [3.1 mm] Cable

# Drop Feeding System Components

## Drop Tube and Mount Kits

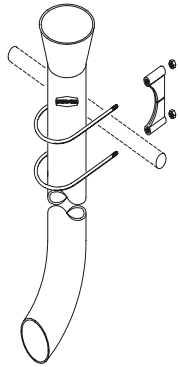

- PART NO 8532-48 PVC DROP TUBE 48 INCH LENGTH (121.92 cm) Not for swine application
- PART NO 8532-58 PVC DROP TUBE 58 INCH LENGTH (147.32 cm) Not for swine application
- PART NO 6477 1/4-20 "U" BOLT
- PART NO 4135 CLAMP
- PART NO 751 1/4-20 HEX NUT
- PART NO 6508 HORIZONTAL MOUNT KIT

PARTS OF HORIZONTAL MOUNT KIT

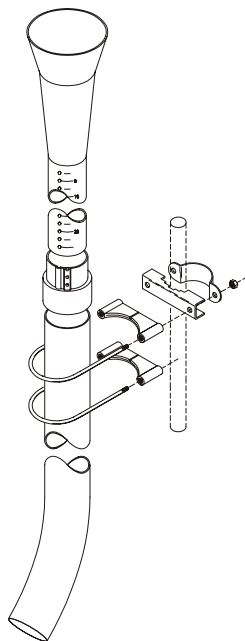

- PART NO 38724 TWO PIECE DROP TUBE 58" (147.32cm) combined length
- PART NO 34408 ADJUSTABLE DROP TUBE
- PART NO 38629 METAL DROP TUBE
- PART NO 6477 1/4-20 "U" BOLT
- PART NO 4139 TUBE CLAMP WELDMENT
- PART NO 7821 CLAMP BRACKET
- PART NO 6630 TOP CLAMP
- PART NO 751 1/4-20 HEX NUT
- PART NO 7566 VERTICAL MOUNT KIT

PARTS OF THE VERTICAL MOUNT KIT

DROPTUBE.CDR

# Drop Feeder Actuator

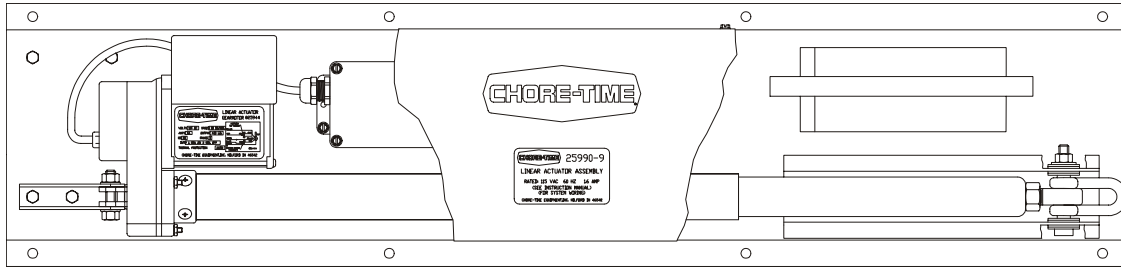

## LINEAR ACTUATOR

- PART NO 28990-9      LINEAR ACTUATOR 220V-60HZ-1PH  
120 MAX DROP FEEDER
  
- PART NO 28990-18      LINEAR ACTUATOR 220V-60HZ-1PH  
240 MAX DROP FEEDER

## ACTUATOR MISC.

- PART NO 6306      MANUAL TRIP LEVER  
OPERATES 30-40 FEEDERS



- PART NO 29428      DOUBLE DRUM WINCH  
OPERATES UP TO 200 FEEDERS

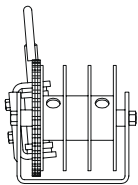

- PART NO 2884-1      DRIVE TUBE (USE WITH 29428)

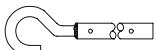

- PART NO 2885      DRIVE HANDLE (USE WITH 2884-1)



- PART NO 9720      ANTI-CABLE WRAP KIT

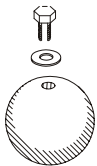

- PART NO 26051      WEIGHT KIT  
THIS KIT IS USED TO PROVIDE  
TENSION FOR THE MAIN CABLE  
THAT OPENS THE OUTLET

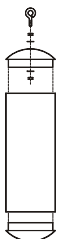

DROPACC,CDR

## Drop Feeders

Drop Feeder	
Part No.	Description
30361-1	MODEL 55 Drop Feeder
30361-2	MODEL 75 Drop Feeder
30361-3	MODEL HMC Drop Feeder

Drop Feeder Components		
Item	Part No.	Description
1	30373-1	MODEL 55 Drop Feeder Body
	30373-2	MODEL 75 Drop Feeder Body
	30373-3	MODEL HMC Drop Feeder Body
2	13057	Cable Clamp (Used to connect dump ball assembly to main cable)
3	26138	Shut-off Slide (Used to keep a feeder from filling)
4	33884	Adjustment Slide (Used to set the amount of feed to be dispensed from each feeder)
5	9965	Hole Plug (Used to cover access hole)
6	8643	Hose Clamp (Used to secure the drop feeder to the tube Model 55)
	6183	Hose Clamp (Used to secure the drop breeder to the tube Model 75 and HMC)
7	6296	Dump Ball Assy (Used with all Drop Feeders)

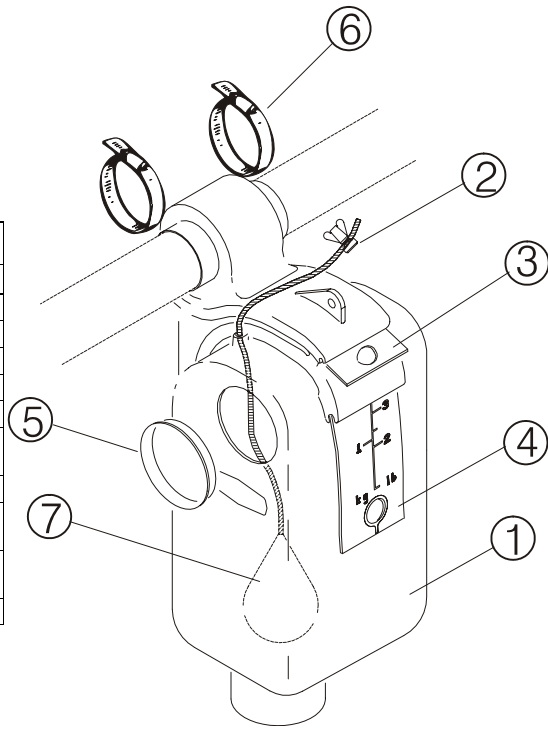

Electrical Parts for Drop Feeder Control Units	
Part No.	Description
28702	Delay Kit (Delays motor start-up to allow manual trip lever to function on mechanical control units)
28904	240 Volt Relay (For proximity switch application)
34255	Proximity Switch
23779	1/2" Liquid Tight Connector
7114	Actuator Switch (For 30370 Control Units)

## Farrowing Drop

Farrowing Drop	
Part No.	Description
44058	11 lb. Farrowing Drop Feeder Kit

**Manually operated Drop Feeder**  
**For: Model 55 or Model 75 Outlet Assembly**

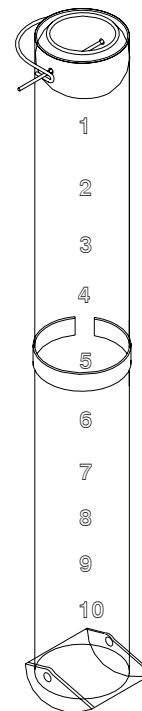

## Drop Feeder Control Units

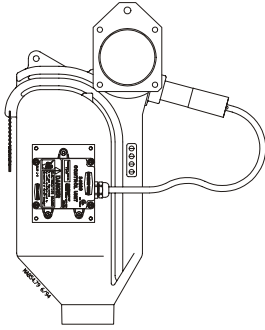

### DEAD END (TERMINAL) DROP FEEDER CONTROL UNITS

**PART NO 34800-10** 220V-50/60HZ-1PH  
MODEL 55 DROP FEEDER CONTROL UNIT (COMPLETE)

**PART NO 34800-11** 220V-50/60HZ-1PH  
MODEL 75 DROP FEEDER CONTROL UNIT (COMPLETE)

**PART NO 34800-12** 220V-50/60HZ-1PH  
MODEL HMC DROP FEEDER CONTROL UNIT (COMPLETE)

### DROP FEEDER CONTROLS AND INTERMEDIATE CONTROLS WITH PROXIMITY SWITCHES

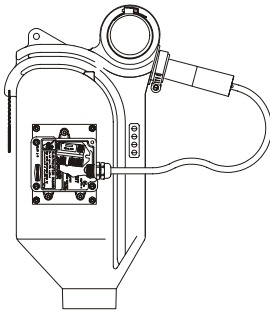

THE DROP FEED CONTROL UNIT CONTROLS THE DELIVERY AUGER MOTOR,

**PART NO 34800-7** 220V-50/60HZ-1PH  
MODEL 55 INTERMEDIATE DROP FEEDER CONTROL UNIT (COMPLETE) / MULTIFLO CONTROL UNIT

**PART NO 34800-8** 220V-50/60HZ-1PH  
MODEL 75 INTERMEDIATE DROP FEEDER CONTROL UNIT (COMPLETE)

**PART NO 34800-9** 220V-50/60HZ-1PH  
MODEL HMC INTERMEDIATE DROP FEEDER CONTROL UNIT (COMPLETE)

### MECHANICAL DROP FEEDER END CONTROL UNITS

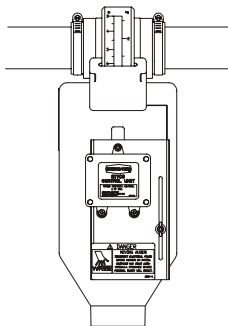

DROPCONT.CDR

**PART NO 30370-1** 220V-50/60HZ-1PH  
MULTIFLO DROP FEEDER CONTROL UNIT (COMPLETE)

**PART NO 30370-2** 220V-50/60HZ-1PH  
MODEL 55 DROP FEEDER CONTROL UNIT (COMPLETE)

**PART NO 30370-3** 220V-50/60HZ-1PH  
MODEL 75 DROP FEEDER CONTROL UNIT (COMPLETE)

**PART NO 30370-4** 220V-50/60HZ-1PH  
MODEL HMC DROP FEEDER CONTROL UNIT

# Suspension Components

## CABLES

- PART NO 4973 3/32 INCH 7X7 GALV CABLE  
BREAK STRENGTH 920#
- PART NO 7130 3/32" 7 X 7 STAINLESS STEEL CABLE  
BREAK STRENGTH 910#
- PART NO 8580 1/8" 7 X 7 STAINLESS STEEL CABLE  
BREAK STRENGTH 1,700#
- PART NO 27975 1/8 INCH 7X7 GALV CABLE  
BREAK STRENGTH 1,799#
- PART NO 1213 3/16 INCH 7X7 GALV. CABLE  
BREAK STRENGTH 3,700#
- PART NO 13976 3/16 INCH 7 X 19 GALV CABLE  
BREAK STRENGTH 4,200#

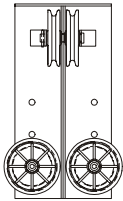
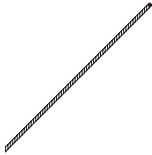

PART NO 27111 TWO-WAY PULLEY KIT 90 DEGREE

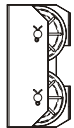

PART NO 27302 DOUBLE PULLEY



PART NO 7886 PULLEY ASSEMBLY

## CEILING SUPPORT



PART NO 1214 STANDARD SCREW HOOK WORKING LOAD 200 #

PART NO 2041 LARGE SCREW HOOK WORKING LOAD 200 #

DROPSUSP.CDR

## CABLE CLAMPS



PART NO 732 CABLE CLAMP FOR 3/16 INCH CABLE



PART NO 14898 CABLE CLAMP FOR 1/8 INCH CABLE

PART NO 13057 PLASTIC CABLE CLAMP FOR 1/8 INCH CABLE AND ROPE



PART NO 6478 SPLIT BOLT FOR 3/32 INCH CABLE

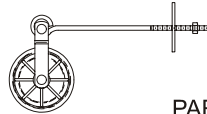

PART NO 2617 MASTER PULLEY



PART NO 2500 LARGE PULLEY WORKING LOAD 1,000#



PART NO 2501 DOUBLE EYE PULLET WORKING LOAD 1,000 #

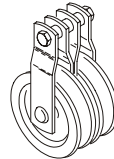

PART NO 2502 DOUBLE PULLEY



PART NO 3004 SMALL PULLEY WORKING LOAD 200 #



PART NO 28649 SPLIT PULLEY WORKING LOAD 200#



PART NO 723 "S" HOOK SMALL MAX WORKING LOAD 52 #

PART NO 2805 "S" HOOK 9 GA. MAX WORKING LOAD 96 #

**This page left blank for notes,**

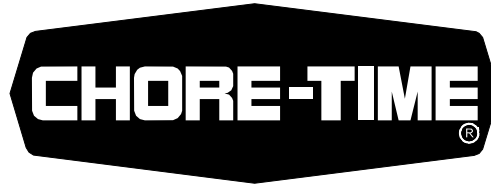

**MADE TO WORK.**

**BUILT TO LAST.®**

**Contact your nearby Chore-Time distributor or representative for additional parts and information.**

**CTB, Inc.  
P.O. Box 2000 • Milford, Indiana 46542-2000 • U.S.A.  
Phone (574) 658-4101 • Fax (877) 730-8825  
E-mail: [poultry@choretime.com](mailto:poultry@choretime.com) • Internet: [www.choretimepoultry.com](http://www.choretimepoultry.com)**

**Printed in the U.S.A.**